

User's Manual

DLP Cinema® Projector Head

NP-02HD

Light Module

NP-24LU01/NP-20LU01/NP-18LU01
NP-24LU03/NP-20LU03/NP-18LU03

DLP Cinema® Projector

**NP-NC2402ML/NP-NC2002ML/
NP-NC1802ML**
**NP-NC2403ML/NP-NC2003ML/
NP-NC1803ML**

Sharp NEC Display Solutions, Ltd.

Model No. (Some models are not available for sales in certain regions.)

NP-02HD/NP-NC2402ML/NP-NC2002ML/NP-NC1802ML/NP-NC2403ML/NP-NC2003ML/NP-NC1803ML
NP-24LU01/NP-20LU01/NP-18LU01/NP-24LU03/NP-20LU03/NP-18LU03

Important Information

Precautions: Please read this manual carefully before using your NP-02HD/NP-NC2402ML/NP-NC2002ML/NP-NC1802ML/NP-NC2403ML/NP-NC2003ML/NP-NC1803ML and keep the manual handy for future reference. The NP-02HD (projector head) is called the “projector” in this manual.

- DLP (Digital Light Processing), DLP Cinema and DLP Cinema logo are trademarks of Texas Instruments.
- Microsoft, Windows and Internet Explorer are either registered trademarks or trademarks of Microsoft Corporation in the United States and/or other countries.
- Mozilla and Firefox are either registered trademarks or trademarks of the Mozilla Foundation in the United States and/or other countries.
- Oracle and Java are registered trademarks of Oracle and/or its affiliates.
- Linux is a registered trademark of Linus Torvalds in the United States and/or other countries.
- Other product names and logos mentioned in the user’s manual may be the trademarks or registered trademarks of their respective holders.
- The display screens and illustrations shown in this manual may differ slightly from the actual ones.
- GPL/LGPL Software Licenses
- The product includes software licensed under GNU
- General Public License (GPL), GNU Lesser General Public License (LGPL), and others.
- For more information on each software, see “readme.pdf” inside the “about GPL&LGPL” folder on the supplied CD-ROM.

WARNING

TO REDUCE THE RISK OF FIRE OR ELECTRIC SHOCK, DO NOT EXPOSE THIS APPLIANCE TO RAIN OR MOISTURE.

CAUTION

TO PREVENT ELECTRIC SHOCK, DO NOT OPEN TOP COVER. NO USER SERVICEABLE PARTS INSIDE.



This symbol warns the user that uninsulated voltage within the unit may have sufficient magnitude to cause electric shock. Therefore, it is dangerous to make any kind of contact with any part inside of this unit.



This symbol alerts the user that important literature concerning the operation and maintenance of this unit has been included. Therefore, it should be read carefully in order to avoid any problems.

Laser Safety Caution

This product is classified as Class 1 of IEC 60825-1 Third edition 2014. This product is classified as RG3 of IEC/EN 62471-5 First edition 2015.

This product is classified as RG3 of IEC 62471:2006.(for USA). Obey the laws and regulations of your country in relation to the installation and management of the device.

CAUTION

Use of controls or adjustments of procedures other than those specified herein may lead to hazardous laser radiation exposure.

- Hazardous optical radiation is emitted from this product, RG3 IEC 62471:2006. (for USA).
- No direct exposure to the beam shall be permitted, RG3 IEC/EN 62471-5:2015.
- Operators shall control access to the beam within the hazard distance or install the product at the height that will prevent spectators’ eyes from being in the hazard distance.
- Do not look at operating light source. Eye injury may result, RG3 IEC 62471:2006. (for USA)
- No direct exposure to beam shall be permitted, RG3 IEC 62471:2006. (for USA).
- Not for household use, RG3 IEC 62471:2006. (for USA)
- This projector must be installed high enough to provide clearance for people who may walk beneath the beam path or hazard distance, RG3 IEC 62471:2006. (for USA)
- Direct exposure of human eyes to beam is prohibited.
- The following graphic symbol indicating that looking into the projector is prohibited is displayed on the projector cabinet.



- Do not look at the projected light using optical devices (magnifying glasses, reflectors, etc.). Doing so could result in vision impairment.
- When performing the lens shift adjustment, make sure that you are behind or beside the projector. Doing so from the front of the projector may cause intense light to enter into your eyes, resulting in damage to them.
- This projector, which is an RG3 product, is for business use and must be installed in location where safety is assured. For this reason, installation of the projector and mounting and removal of the lens unit must be performed by professional service personnel. To do the works, be sure to consult your dealer. NEVER install the projector by end users. Doing so may cause visual impairment and other injuries.
- Keep any items such as magnifying glass out of the light path of the projector. The light being projected from the lens is extensive, therefore any kind of abnormal objects that can redirect light coming out of the lens, can cause unpredictable outcome such as fire or injury to the eyes.
- When turning on the projector, ensure that nobody is facing towards the lens in the path of the light emitted from the laser.
- This product can only be operated in theaters by specified personnel. Customers should not operate this product.

Machine Noise Information Regulation - 3. GPSGV,

The highest sound pressure level is less than 70 dB (A) in accordance with EN ISO 7779.

WARNING

Operation of this equipment in a residential environment could cause radio interference.

FCC Information (for USA only)



WARNING

- The Federal Communications Commission does not allow any modifications or changes to the unit EXCEPT those specified by Sharp NEC Display Solutions of America, Inc. in this manual. Failure to comply with this government regulation could void your right to operate this equipment.
- This equipment has been tested and found to comply with the limits for a class A digital device, pursuant to Part 15 of the FCC Rules. These limits are designed to provide reasonable protection against harmful interference when the equipment is operated in a commercial environment. This equipment generates, uses, and can radiate radio frequency energy and, if not installed and used in accordance with the instruction manual, may cause harmful interference to radio communications. Operation of this equipment in a residential area is likely to cause harmful interference in which case the user will be required to correct the interference at his own expense.

Supplier's declaration of conformity (for USA only)

This device complies with Part 15 of the FCC Rules. Operation is subject to the following two conditions.

(1) This device may not cause harmful interference, and (2) this device must accept any interference received, including interference that may cause undesired operation.



U.S. Responsible Party: Sharp NEC Display Solutions of America, Inc.
Address: 3250 Lacey Rd, Ste 500
Downers Grove, IL 60515
Telephone Number: 630-467-3000
Type of Product: Projector
Equipment Classification: Class A Peripheral
Model Number: NP-02HD/NP-NC2402ML/
NP-NC2002ML/NP-NC1802ML/
NP-NC2403ML/NP-NC2003ML/
NP-NC1803ML



WARNING

THE END USER IS NOT ALLOWED TO OPEN OR MODIFY THE PRODUCT.
NO USER SERVICEABLE PARTS.
MAINTAIN AND SERVICE OF THE PRODUCT IS ONLY TO BE HANDLED BY NEC AUTHORIZED TECHNICIANS.

Important Safeguards

These safety instructions are to ensure the long life of your projector and to prevent fire and shock. Please read them carefully and heed all warnings.

Installation

1. Do not point the projection beam toward other people or reflective objects.
2. Consult your dealer for information about transporting and installing the projector. Do not attempt to transport and install the projector yourself.
The projector must be installed by qualified technicians in order to ensure proper operation and reduce the risk of bodily injury.
3. Place the projector on a flat, level surface in a dry area away from dust and moisture. Tilting the front of the projector up or down from level could reduce laser life. Do not put the projector on its side when the laser is on. Doing so may cause damage to the projector.
4. Do not place the projector in direct sunlight, near heaters or heat radiating appliances.
5. Exposure to direct sunlight, smoke or steam could harm internal components.
6. Handle your projector carefully. Dropping or jarring your projector could damage internal components.
7. When moving the projector, be sure to remove the lens from the projector before moving it.
8. To carry the projector, a minimum of six persons are required.
9. Do not hold the lens part with your hand. Otherwise the projector may tumble or drop, causing personal injury.
10. Do not place heavy objects on top of the projector.
11. Turn off the projector, and disconnect the power cable before moving the projector.
For C2 connection, turn off the projector, shut down the AC power to the projector and the light using a circuitbreaker.
Disconnect the cables between devices and the light before moving the projector.
12. The cooling fan settings need to be configured when using the projector in a location at an altitude of approximately 5500 feet/1600 meters or higher. Consult your dealer in advance.
13. Turn off the projector when removing and installing lenses. Failure to do so can cause loss of vision.
For mounting or replacing the lens, please contact your dealer.
14. Do not install and store the projector in the below circumstances.
Failure to do so may cause of malfunction.
 - In powerful magnetic fields
 - In corrosive gas environment
 - Outdoors
15. If you wish to have the projector installed on the ceiling;
 - Do not attempt to install the projector yourself.
 - The projector must be installed by qualified technicians in order to ensure proper operation and reduce the risk of bodily injury.
 - In addition, the ceiling must be strong enough to support the projector and the installation must be in accordance with any local building codes.
 - Please consult your dealer for more information.
16. When moving the projector, check the following:
 - That the projector is turned off, the power plug is disconnected from the outlet
 - That the connector cable that connects the device to the projector is unplugged

Important Information

WARNING

1. Do not cover the lens with the supplied lens cap or equivalent while the projector is on. Doing so can lead to distorting or melting of the cap and burning your hands due to the heat emitted from the light output.
2. Do not place any objects, which are easily affected by heat, in front of the projector lens. Doing so could lead to the object melting from the heat that is emitted from the light output.
The following graphic symbol is shown on the projector cabinet.



When using the projector tilted in the forward or backward direction, use it in the range of (+15° to -15°) from horizontal. If you tilt it outside of this range or tilt it to the left or right, it may become damaged.

If the projector is tilted outside of this range when used tilted in the forward or backward direction, "TiltDegreeOver" is displayed on the LCD screen. If this message appears, change the installation of the projector so that the angle is within the given range from horizontal.

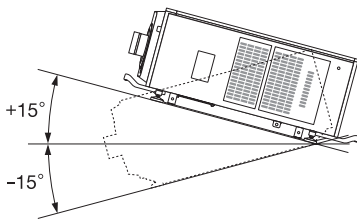

When installed on a floor or a desktop

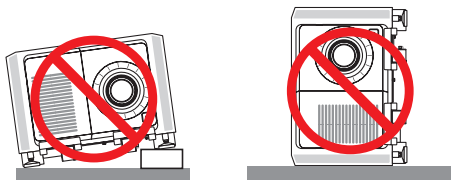

CAUTION

This equipment is not suitable for use in locations where children are likely to be present

Power Supply

1. Consult your dealer for installing the power cable to the projector. **DO NOT** install the power cable by yourself. Doing so may cause a fire or electric shock.
The projector is so designed that it operates with the power supply voltage described below.
For C1 connection
(When the AC power to the projector power supply and the light power supply is provided by a single cable)
 - AC 200V-240V single phase 50/60HzFor C2 connection
(When the AC power to the projector power supply and the light power supply is provided by separate cables)

- AC 100V-240V single phase 50/60Hz (projector power supply)
 - AC 200V-240V single phase 50/60Hz (light power supply)
- Ensure that your power supply fits this requirement before attempting to use your projector.
2. The power cable is not included with the projector. Ask your dealer for the power cable to select and purchase. Use a power cable that meets the standards and power supply voltage of the country where you are using the projector.
Refer to "2-2. Connecting the Power Cable" (page 27) for details on connecting the power cable.
 3. Handle the power cable carefully. A damaged or frayed power cable can cause electric shock or fire.
 - Do not bend or tug the power cable excessively.
 - Do not place the power cable under the projector, or any heavy object.
 - Do not cover the power cable with other soft materials such as rugs.
 - Do not heat the power cable.
 - Do not change the arrangement of the installed power cable.
 4. If the projector will not be used for an extended period of time, turn off the projector, and disconnect the power plug from the outlet.
 5. Placing the power cable and the signal cable closely to each other can cause beat noise. If this happens, keep the two separated so that beat noise is not generated. Beat noise is corruption of the picture often seen as a rolling band moving through the image.
 6. Do not touch the projector during a thunder storm. Doing so can cause electrical shock or fire.
 7. When installed on the ceiling, install the breaker in a location that is easy to reach by hand.

Fire and Shock Precautions

1. Ensure that there is sufficient ventilation and that vents are unobstructed to prevent potentially dangerous concentrations of ozone and the build-up of heat inside your projector. Allow at least 24 inches (60 cm) of space between your projector and a wall. In particular, clear a space of 26.7 inches (70 cm) or more in front of the air outlet on the rear surface and 12 inches (30 cm) or more on the upper part of the projector body.
2. Prevent foreign objects such as paper clips and bits of paper from falling into your projector. Do not attempt to retrieve any objects that might fall into your projector. Do not insert any metal objects such as a wire or screwdriver into your projector. If something should fall into your projector, shut down the AC power to the projector immediately and have the object removed by a qualified service person.
For C2 connection, turn off the projector, shut down the AC power to the projector and the light using a circuit breaker, and contact your dealer/distributor.
3. Turn off the projector, shut down AC power by using a circuit breaker and contact qualified service personnel under the following conditions. For C2 connection, turn off the projector, shut down the AC power to the projector and the light using a circuit breaker, and contact your dealer/distributor for a repair.
 - When the power cable or plug is damaged or frayed.
 - If liquid has been spilled into the projector, or if it has been exposed to rain or water.

- If the projector does not operate normally when you follow the instructions described in this user's manual.
 - If the projector has been dropped or the cabinet has been damaged.
 - If the projector exhibits a distinct change in performance, indicating a need for service.
4. Keep any items such as magnifying glass out of the light path of the projector. The light being projected from the lens is extensive, therefore any kind of abnormal objects that can redirect light coming out of the lens, can cause unpredictable outcome such as fire or injury to the eyes.
 5. Never remove or open the projector cabinet and never modify the projector. Otherwise, fire, electric shock, or leakage of laser light may cause visual impairment or burn injuries.
 6. When using a LAN cable:
For safety, do not connect to the connector for peripheral device wiring that might have excessive Voltage.
 7. Do not try to touch the air outlets on the projector during normal projector operation as it is hot.

Cleaning

1. Shut down AC power by using a circuit breaker before cleaning.
For C2 connection, turn off the projector, shut down the AC power to the projector and the light using a circuit breaker.
2. Clean the cabinet periodically with a cloth. If heavily soiled, use a mild detergent. Never use strong detergents or solvents such as alcohol or thinner.
3. Use a blower or lens paper to clean the lens, and be careful not to scratch or mar the lens.
4. Do not handle the projector and the power cable with wet hands. Doing so can cause electrical shock or fire.

CAUTION

1. Do not shut down AC power to the projector under the following conditions. Doing so can damage the projector.
 - While projecting images
 - While cooling after the power is turned off. (The STATUS indicator LED blinks in orange while the fan is rotating, and "cooling..." is displayed on the LCD screen.)
 - When using the IMB: 90 seconds
 - During IMB Operation (if the projector is not in standby state)
2. Do not turn of the AC power for 90 seconds after the Laser is turned on and while the POWER indicator is blinking green. Doing so could cause premature Laser failure.
3. Keep hands away from the lens mounting portion while the lens shift is in operation. Failure to do so could result in fingers being pinched between the cabinet and lens cover.
4. When main body is damaged, cooling fluids may come out of internal part.
Should this happen, immediately turn off the AC supply to the projector and contact your dealer.
DO NOT touch and drink the cooling fluid.
When the cooling fluids are swallowed or contacted with your eyes, please consult with doctors immediately.

Caution on Carrying the Projector/Handling the Optional Lens

The projector should always be carried by at least 6 people, holding the handles on the front and back of the main body and the grips on the bottom. Remove the lens unit from the projector body when moving the projector.

When installing / removing a lens, shut down the AC power to the projector.

When shipping the projector with the lens, remove the lens before shipping the projector. Always attach the dust cap to the lens whenever it is not mounted on the projector. The lens and the lens shift mechanism may encounter damage caused by improper handling during transportation.

Light Module

1. A light module containing multiple laser diodes is included in the product as the light source.
2. These laser diodes are sealed in the light module. No maintenance or service is required for the performance of the light module.
3. End user is not allowed to replace the light module.
4. Contact qualified distributor for light module replacement and further information.

Cable information

Use shielded cables or cables attached ferrite cores so as not to interfere with radio and television reception.

For details, please refer to "2. Installation and Connection" in this user's manual.

Installing the Projector

This projector is an RG3 product. The projector is for professional use and must be installed in location where safety is assured. For this reason, be sure to consult your dealer as installation and attachment/detachment of the lens unit must be performed by a professional service personnel. Never try to install the projector by yourself. This may result in visual impairment etc.

Connecting the power cord to earth

This equipment is designed to be used in the condition of the power cord connected to earth. If the power cord is not connected to the earth, it may cause electric shock. Please make sure the power cord is earthed properly.
Do not use a 2-core plug converter adapter.

Handling the power cord

- When connecting the power cord to the projector's AC IN terminal, make sure the connector is fully and firmly inserted. Be sure to fix the power cord using the power cord stopper. Loose connection of the power cord could lead to fire or electric shock.
- Do not connect or disconnect the power cord with wet hands. Doing so could result in electric shock.

Lens shift, focus and zoom operations

- When shifting the lens or adjusting the focus or zoom, do so from either behind or to the side of the projector. If adjustments are performed from the front, your eyes could be exposed to strong light and get injured.
- Keep your hands away from the lens area when performing the lens shift operation. If not, your fingers could get caught in the gap between the cabinet and the lens.

Important Information

Disposing of your used product



EU-wide legislation as implemented in each Member State requires that used electrical and electronic products carrying the mark (left) must be disposed of separately from normal household waste.

This includes projectors and their electrical accessories. When you dispose of such products, please follow the guidance of your local authority and/or ask the shop where you purchased the product.

After collecting the used products, they are reused and recycled in a proper way. This effort will help us reduce the wastes as well as the negative impact to the human health and the environment at the minimum level.

The mark on the electrical and electronic products only applies to the current European Union Member States.

Outside the European Union

If you wish to dispose of used electrical and electronic products outside the European union, please contact your local authority and ask for the correct method of disposal.



For EU: The crossed-out wheeled bin implies that used batteries should not be put to the general household waste! There is a separate collection system for used batteries, to allow proper treatment and recycling in accordance with legislation.

According to the EU directive 2006/66/EC, the battery can't be disposed improperly. The battery shall be separated to collect by local service.

For questions relating to unclear points or repairs

Contact your dealer or the following support branch for questions relating to unclear points, malfunctions and repairs of the product.

In Europe

Company Name: Sharp NEC Display Solutions Europe GmbH
Address: Landshuter Allee 12-14, D-80637 Munich, Germany
Telephone: +49 89 99699 0
Fax Line: +49 89 99699 500
Email Address: infomail@nec-displays.com
WEB Address: <https://www.sharpnecdisplays.eu>

In North America

Company Name: Sharp NEC Display Solutions of America, Inc.
Address: 3250 Lacey Rd, Ste 500
Downers Grove, IL 60515 U.S.A.
Telephone: +1 866-632-6431
Email: cinema.support@sharpnec-displays.com
WEB Address: <https://www.sharpnecdisplays.us>

In China

Company Name: NEC (China) Co., Ltd.
Address: 6F, Landmark diplomatic office building D2,
No. 19 East Road, Chaoyang District,
Beijing 100600, R.P.C.
Telephone: 010-59342706
Email Address: nec-support@nec.cn

In Hong Kong and Taiwan

Company Name: Strong Westrex, Inc.
Address: Room 4108 China Resources Building, No. 26
Harbour Road, Wanchai, Hong Kong
Telephone: +852 2827 8289
Fax Line: +852 2827 5993
Email Address: Felix.chen@btn-inc.com

In South Korea

Company Name: Hyosung ITX Co., Ltd.
Address: 1F, Ire Building, 2, Yangpyeong-dong 4-ga,
Yeongdeungpo-gu, Seoul, Korea 150-967
Telephone: +82-2-2102-8591
Fax Line: +82-2-2102-8600
Email Address: moneybear@hyosung.com
WEB Address: <http://www.hyosungitx.com>

In Australia and New Zealand

Company Name: NEC Australia Pty Ltd
Address: 26 Rodborough Road Frenchs Forest NSW 2086
Telephone: 131 632 (from anywhere in Australia)
Email Address: displays@nec.com.au
WEB Address: <http://www.nec.com.au>

In Thailand, Singapore, Malaysia, Indonesia and Philippines

Company Name: Goldenduck International Co., Ltd.
Address: 65 Soi Phutthamothon Sai 1, 21 Bangramad,
Talingchan, Bangkok, Thailand 10170
Telephone: +66-2887-8807
Fax Line: +66-2887-8808
Email Address: contact@goldenduckgroup.com

Label Information

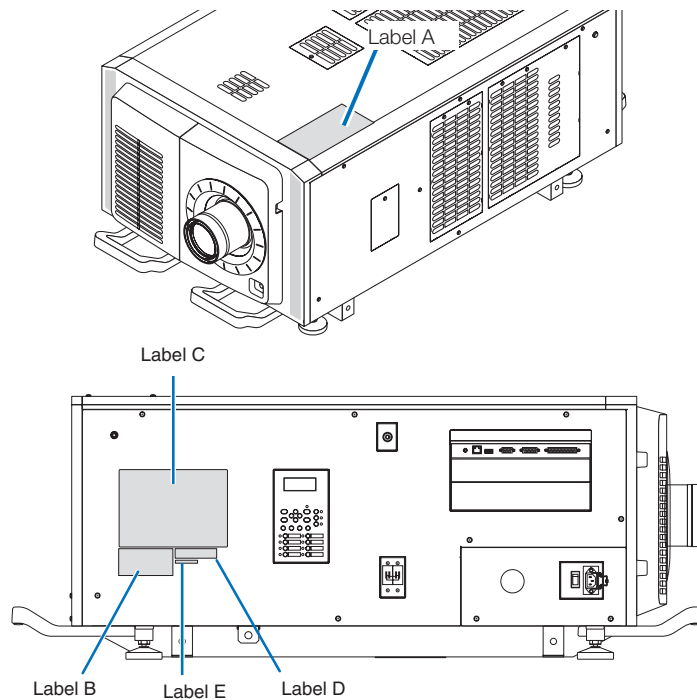

About the laser module used in the light source

- This product has a built-in laser module. Control and adjustment procedures other than those described in this document may result in exposure to hazardous laser radiation.
- This product is classified as a Class 1 of Laser Product Safety Standard JIS C 6802:2014, IEC 60825-1 3rd Edition:2014. This product is classified as Risk Group 3 of IEC/EN 62471-5 1st Edition:2015.
- This product is classified as RG3 of IEC 62471:2006. (for USA).
- This product complies with performance standards for laser products under 21 CFR Part 1040 except with respect to those characteristics authorized by Variance Number 2015-V-3435 effective on April 7, 2016.

Outline of laser emitted from the built-in light module:

Wave length: Red 635–647 nm, Blue 450–470 nm
 Maximum power: Red 91 W, Blue 978 W

Radiation pattern from the lens (the protective housing):

Wave length: Red 635–647 nm, Blue 450–470 nm
 Maximum laser radiation output: Red 500 mW, Blue 900 mW

The explanatory label of the laser product is put on the top of the projector.

CLASS 1 LASER PRODUCT



WARNING RG3 PRODUCT

- No direct exposure to the beam shall be permitted.
- Do not look into the projector's lens. Serious damage to your eyes could result.
- Hazardous optical radiation is emitted from this product.
- Not for household use.
- Operators shall control access to the beam within the hazard distance and install the product at the height that will prevent exposures of spectators' eyes within the hazard distance.
- This projector must be installed high enough to provide clearance for people who may walk beneath the beam path or hazard distance. (FDA)

Important Information

Label A
Lamp Warning Label



RISK GROUP 3
WARNING
DO NOT LOOK INTO THE BEAM.
NO DIRECT EYE EXPOSURE TO THE BEAM IS PERMITTED.
HAZARD DISTANCE: REFER TO THE MANUAL.

GROUPE DE RISQUE 3
AVERTISSEMENT
NE PAS REGARDER DIRECTEMENT DANS LE FAISCEAU.
L'EXPOSITION DIRECTE DES YEUX AU FAISCEAU EST INTERDITE.
DISTANCE A RISQUE: SE REPORTER AU MANUEL.

RISIKOGRUPPE 3
WARNUNG
SCHAUEN SIE NICHT IN DEN STRAHL.
DIREKTER AUGENKONTAKT MIT DEM STRAHL IST NICHT ERLAUBT.
SICHERHEITSABSTAND: SIEHE HANDBUCH.

ГРУППА РИСКА 3
ПРЕДУПРЕЖДЕНИЕ
НЕ СМОТРИТЕ НА ЛУЧ.
ЗАПРЕЩАЕТСЯ ЛЮБОЕ ПРЯМОЕ ВОЗДЕЙСТВИЕ ЛУЧА НА ГЛАЗА.
ОПАСНОЕ РАССТОЯНИЕ: СМ. РУКОВОДСТВО ПО ЭКСПЛУАТАЦИИ.

リスクグループ 3
警告
ビームを見ないこと
目へのビームの直接被ばくを禁止する。
障害距離:取扱説明書を参照。

위험 그룹 3
경고
빔을 눈으로 보지 마십시오.
빔을 직접 눈에 노출하는 것은 허용되지 않습니다.
위험 거리: 설명서를 참조하십시오.

風險群組 3
警告
勿直視光源。
避免眼睛受到直接照射。
危害距離:請參閱說明書。

风险组别 3
警告
请勿注视光束。
不允许将眼睛暴露于光束中。
有害距离: 请参阅手册。
IEC/EN 62471-5:2015



FOR NORTH AMERICA

RISK GROUP 3
WARNING
HAZARDOUS OPTICAL RADIATION EMITTED FROM THIS PRODUCT.
DO NOT LOOK AT OPERATING LIGHT SOURCE.
EYE INJURY MAY RESULT.
HAZARD DISTANCE: REFER TO THE MANUAL.
NO DIRECT EXPOSURE TO BEAM SHALL BE PERMITTED.
NOT FOR HOUSEHOLD USE.

GROUPE DE RISQUE 3
AVERTISSEMENT
RADIATIONS OPTIQUES DANGEREUSES EMISES PAR CE PRODUIT.
NE REGARDEZ PAS DIRECTEMENT LA SOURCE LUMINEUSE.
CELA POURRAIT ENTRAÎNER DES BLESSURES AUX YEUX.
DISTANCE A RISQUE: SE REPORTER AU MANUEL.
L'EXPOSITION DIRECTE AU RAYON DOIT ÊTRE AUTORISÉE.
NE CONVIENT PAS A UN USAGE DOMESTIQUE.

IEC/TR 62471-2:2009
IEC 62471:2006/EN 62471:2008



Label B
Laser Explanatory Label

CLASS 1 LASER PRODUCT
LASERPRODUKT DER KLASSE 1
PRODUIT LASER DE CLASSE 1
ЛАЗЕРНОЕ ИЗДЕЛИЕ 1 КЛАССА ОПАСНОСТИ
1类激光产品
第一級雷射產品
등급1 레이저 제품
IEC 60825-1:2014

激光辐射
避免眼或皮肤受到直射或散射辐射的照射
4类激光产品
波长: 红色 635-647nm
蓝色 450-470nm
最大输出: 红色 500mW
蓝色 900mW
GB 7247.1-2012



クラス1レーザ製品
JIS C 6802:2014



Label C (NP-02HD)

NEC MODEL No. NP-02HD

C1: 200-240V ~ 50/60Hz 18.1A
 C2: 100-240V ~ 50/60Hz 6.0A for PJ POWER
 200-240V ~ 50/60Hz 15.2A for LIGHT POWER

XXXX XXXX
3264857304

Sharp NEC Display Solutions, Ltd.
4-28, Mita 1-chome, Minato-ku, Tokyo, Japan

Contact address for EMEA
Sharp NEC Display Solutions Europe GmbH
Landshtuter Allee 12-14
80637 Munich, Germany

Tegangan dan Frekuensi:
C1: 200-240V ~ 50/60Hz
C2: 100-240V ~ 50/60Hz(PROYEKTOR CATU DAYA)
200-240V ~ 50/60Hz(CAHAYA CATU DAYA)
Produksi China

商品名稱：投影机 型號：NP-02HD
 電源 / 額定輸入電流：
 C1: 200-240V ~ 50/60Hz 18.1A
 C2: 100-240V ~ 50/60Hz 6.0A (投影机 電源)
 200-240V ~ 50/60Hz 15.2A (光 電源)
 生產國別：中國

제품명: 프로젝터
 모델명: NP-02HD
 제조/국가: 델타 일렉트로닉스 (장수) 유한회사 / 중국
 인력전력:
 C1: 200-240V ~ 50/60Hz, 18.1A
 C2: 100-240V ~ 50/60Hz, 6.0A (프로젝터 전원)
 200-240V ~ 50/60Hz, 15.2A (빛 전원)
 생산일: 일련번호에 표기
 인증 서비스 센터 전화 번호:
 080-022-1155 (호성ITX주식회사)
 *본 라벨과 전화번호는 국내 규정 내에서
 적절한 목적으로 로만 사용되어야 합니다.

THIS CABINET IS CONSTRUCTED OF METAL(AL)

警告	高压注意	使用上の注意 イ. 通風孔をふさがらないでください。内部温度の上昇を招き故障の原因になります。 ロ. 湿度の高い場所や湿気の多い場所での使用はさけてください。
-----------	-------------	--

CAUTION: TO PREVENT ELECTRIC SHOCK, DO NOT OPEN TOP COVER. NO USER-SERVICEABLE PARTS INSIDE.
ATTENTION: AFIN DE PREVENIR UN CHOC ELECTRIQUE, NE PAS ENLEVER LE COUVERCLE.S'ADRESSER A UN REPARATEUR COMPETENT.
ВНИМАНИЕ: ВО ИЗБЕЖАНИЕ УДАРА ЭЛЕКТРИЧЕСКИМ ТОКОМ НЕ ОТКРЫВАЙТЕ ВЕРХНЮЮ КРЫШКУ.
 ВНУТРИ НЕТ ДЕТАЛЕЙ, ОБСЛУЖИВАЕМЫХ ПОЛЬЗОВАТЕЛЕМ.

주의: 전기충격 방지를 위해 캐비닛을 열지 마십시오. 내부에는 사용자를 위한 서비스가능 부품이 들어있지 않습니다.
ACHTUNG: Zur Vermeidung eines elektrischen Schlages, öffnen Sie das Gehäuse nicht selbst.
 In diesem Gerät sind keine Teile enthalten, die vom Nutzer gewartet werden können.
 ZUR TRENNUNG VOM NETZ IST DER NETZSTECKER AUS DER STECKDOSE ZU ZIEHEN!

注意: 請勿打開頂蓋・小心高壓電擊・機內並無用戶配件。

この装置は、クラスA機器です。この装置を住宅環境で使用すると電波妨害を引き起こすことがあります。この場合には使用者が適切な対策を講ずるよう要求されることがあります。 VCCI-A

警告使用者: 此為甲類資訊技術設備, 於居住環境中使用時, 可能會造成射頻擾動。在此種情況下, 使用者會被要求採取某些適當的對策。

THIS DEVICE COMPLIES WITH PART 15 OF THE FCC RULES. OPERATION IS SUBJECT TO THE FOLLOWING TWO CONDITIONS:
 (1) THIS DEVICE MAY NOT CAUSE HARMFUL INTERFERENCE, AND
 (2) THIS DEVICE MUST ACCEPT ANY INTERFERENCE RECEIVED, INCLUDING INTERFERENCE THAT MAY CAUSE UNDESIRABLE OPERATION.
 CAN ICES-3(A)/NMB-3(A)

Проектор
 Модель NP-02HD
 C1: 200-240В ~ 50/60Гц, 18.1А
 C2: 100-240В ~ 50/60Гц, 6.0А Проектор Мощность
 200-240В ~ 50/60Гц, 15.2А Света Мощность
 Сделано в Китае
 Производитель: Дельта Электроникс, Инк.

This product complies with performance standards for laser products under 21 CFR Part 1040 except with respect to those characteristics authorized by Variance Number 2015-V-3435 effective on April 7, 2016.

Label C (NP-NC2402ML)

NEC MODEL No. NP-NC2402ML

C1: 200-240V ~ 50/60Hz 18.1A
 C2: 100-240V ~ 50/60Hz 6.0A for PJ POWER
 200-240V ~ 50/60Hz 15.2A for LIGHT POWER

XXXX XXXX
3264853901

Sharp NEC Display Solutions, Ltd.
4-28, Mita 1-chome, Minato-ku, Tokyo, Japan

Contact address for EMEA
Sharp NEC Display Solutions Europe GmbH
Landshtuter Allee 12-14
80637 Munich, Germany

Tegangan dan Frekuensi:
C1: 200-240V ~ 50/60Hz
C2: 100-240V ~ 50/60Hz(PROYEKTOR CATU DAYA)
200-240V ~ 50/60Hz(CAHAYA CATU DAYA)
Produksi China

商品名稱：投影机 型號：NP-NC2402ML
 電源 / 額定輸入電流：
 C1: 200-240V ~ 50/60Hz 18.1A
 C2: 100-240V ~ 50/60Hz 6.0A (投影机 電源)
 200-240V ~ 50/60Hz 15.2A (光 電源)
 生產國別：中國

제품명: 프로젝터
 모델명: NP-NC2402ML
 제조/국가: 델타 일렉트로닉스 (장수) 유한회사 / 중국
 인력전력:
 C1: 200-240V ~ 50/60Hz, 18.1A
 C2: 100-240V ~ 50/60Hz, 6.0A (프로젝터 전원)
 200-240V ~ 50/60Hz, 15.2A (빛 전원)
 생산일: 일련번호에 표기
 인증 서비스 센터 전화 번호:
 080-022-1155 (호성ITX주식회사)
 *본 라벨과 전화번호는 국내 규정 내에서
 적절한 목적으로 로만 사용되어야 합니다.

THIS CABINET IS CONSTRUCTED OF METAL(AL)

警告	高压注意	使用上の注意 イ. 通風孔をふさがらないでください。内部温度の上昇を招き故障の原因になります。 ロ. 湿度の高い場所や湿気の多い場所での使用はさけてください。
-----------	-------------	--

CAUTION: TO PREVENT ELECTRIC SHOCK, DO NOT OPEN TOP COVER. NO USER-SERVICEABLE PARTS INSIDE.
ATTENTION: AFIN DE PREVENIR UN CHOC ELECTRIQUE, NE PAS ENLEVER LE COUVERCLE.S'ADRESSER A UN REPARATEUR COMPETENT.
ВНИМАНИЕ: ВО ИЗБЕЖАНИЕ УДАРА ЭЛЕКТРИЧЕСКИМ ТОКОМ НЕ ОТКРЫВАЙТЕ ВЕРХНЮЮ КРЫШКУ.
 ВНУТРИ НЕТ ДЕТАЛЕЙ, ОБСЛУЖИВАЕМЫХ ПОЛЬЗОВАТЕЛЕМ.

주의: 전기충격 방지를 위해 캐비닛을 열지 마십시오. 내부에는 사용자를 위한 서비스가능 부품이 들어있지 않습니다.
ACHTUNG: Zur Vermeidung eines elektrischen Schlages, öffnen Sie das Gehäuse nicht selbst.
 In diesem Gerät sind keine Teile enthalten, die vom Nutzer gewartet werden können.
 ZUR TRENNUNG VOM NETZ IST DER NETZSTECKER AUS DER STECKDOSE ZU ZIEHEN!

注意: 請勿打開頂蓋・小心高壓電擊・機內並無用戶配件。

この装置は、クラスA機器です。この装置を住宅環境で使用すると電波妨害を引き起こすことがあります。この場合には使用者が適切な対策を講ずるよう要求されることがあります。 VCCI-A

警告使用者: 此為甲類資訊技術設備, 於居住環境中使用時, 可能會造成射頻擾動。在此種情況下, 使用者會被要求採取某些適當的對策。

THIS DEVICE COMPLIES WITH PART 15 OF THE FCC RULES. OPERATION IS SUBJECT TO THE FOLLOWING TWO CONDITIONS:
 (1) THIS DEVICE MAY NOT CAUSE HARMFUL INTERFERENCE, AND
 (2) THIS DEVICE MUST ACCEPT ANY INTERFERENCE RECEIVED, INCLUDING INTERFERENCE THAT MAY CAUSE UNDESIRABLE OPERATION.
 CAN ICES-3(A)/NMB-3(A)

Проектор
 Модель NP-NC2402ML
 C1: 200-240В ~ 50/60Гц, 18.1А
 C2: 100-240В ~ 50/60Гц, 6.0А Проектор Мощность
 200-240В ~ 50/60Гц, 15.2А Света Мощность
 Сделано в Китае
 Производитель: Дельта Электроникс, Инк.

This product complies with performance standards for laser products under 21 CFR Part 1040 except with respect to those characteristics authorized by Variance Number 2015-V-3435 effective on April 7, 2016.

Important Information

Label C (NP-NC2403ML)



MODEL No. NP-NC2403ML

C1: 200-240V ~ 50/60Hz 18.1A
C2: 100-240V ~ 50/60Hz 6.0A for PJ POWER
200-240V ~ 50/60Hz 15.2A for LIGHT POWER

XXXX XXXX
326468700











Sharp NEC Display Solutions, Ltd.
4-28, Mita 1-chome, Minato-ku, Tokyo, Japan

MADE IN CHINA

Contact address for EMEA
Sharp NEC Display Solutions Europe GmbH
Landshtuter Allee 12-14
80637 Munich, Germany

Tegangan dan Frekuensi:
C1: 200-240V ~ 50/60Hz
C2: 100-240V ~ 50/60Hz (PROYEKTOR CATU DAYA)
200-240V ~ 50/60Hz (CAHAYA CATU DAYA)

Produksi China

THIS CABINET IS CONSTRUCTED OF METAL(AL)

⚠ 警告	⚠ 高圧注意	使用上の注意
	サービスマン以外の方は外装パネルを外さないでください。内部には高電圧部分が多くあり、万一さわると危険です。	イ。通風孔をふさがしないでください。内部温度の上昇を招き故障の原因になります。口。温度の高い場所や湿気の多い場所での使用は避けてください。

CAUTION: TO PREVENT ELECTRIC SHOCK, DO NOT OPEN TOP COVER. NO USER-SERVICEABLE PARTS INSIDE.
ATTENTION: AFIN DE PREVENIR UN CHOC ELECTRIQUE, NE PAS ENLEVER LE COUVERCLE.S'ADRESSER A UN REPARATEUR COMPETENT.
ВНИМАНИЕ: ВО ИЗБЕЖАНИЕ УДАРА ЭЛЕКТРИЧЕСКИМ ТОКОМ НЕ ОТКРЫВАЙТЕ ВЕРХНЮЮ КРЫШКУ. ВНУТРИ НЕТ ДЕТАЛЕЙ, ОБСЛУЖИВАЕМЫХ ПОЛЬЗОВАТЕЛЕМ.
주의: 전기충격 방지를 위해 캐비닛을 열지 마십시오. 내부에는 사용자를 위한 서비스가능 부품이 들어있지 않습니다.
ACHTUNG: Zur Vermeidung eines elektrischen Schlages, öffnen Sie das Gehäuse nicht selbst. In diesem Gerät sind keine Teile enthalten, die vom Nutzer gewartet werden können, ZUR TRENNUNG VOM NETZ IST DER NETZSTECKER AUS DER STECKDOSE ZU ZIEHEN!
注意: 請勿打開頂蓋・小心高壓電擊・機內並無用戶配件・

この装置は、クラスA機器です。この装置を住宅環境で使用すると電波妨害を引き起こすことがあります。この場合には使用者が適切な対策を講ずるよう要求されることがあります。 VCCI-A

警告使用者: 此為甲類資訊技術設備。於居住環境中使用時。可能會造成射頻擾動。在此種情況下。使用者會被要求採取某些適當的對策。

THIS DEVICE COMPIES WITH PART 15 OF THE FCC RULES. OPERATION IS SUBJECT TO THE FOLLOWING TWO CONDITIONS:
 (1) THIS DEVICE MAY NOT CAUSE HARMFUL INTERFERENCE, AND
 (2) THIS DEVICE MUST ACCEPT ANY INTERFERENCE RECEIVED, INCLUDING INTERFERENCE THAT MAY CAUSE UNDESIRABLE OPERATION.
 CAN ICES-003(A)/NMB-003(A)

Проектор
 Модель: NP-NC2403ML
 C1: 200-240В ~ 50/60Гц, 18.1А
 C2: 100-240В ~ 50/60Гц, 6.0А Проектор Мощность
 200-240В ~ 50/60Гц, 15.2А Света Мощность
 Сделано в Китае
 Производитель: Дельта Электроникс, Инк.

Label C (NP-NC2002ML)



MODEL No. NP-NC2002ML

C1: 200-240V ~ 50/60Hz 18.1A
C2: 100-240V ~ 50/60Hz 6.0A for PJ POWER
200-240V ~ 50/60Hz 15.2A for LIGHT POWER

XXXX XXXX
3264654201













Sharp NEC Display Solutions, Ltd.
4-28, Mita 1-chome, Minato-ku, Tokyo, Japan

MADE IN CHINA

Contact address for EMEA
Sharp NEC Display Solutions Europe GmbH
Landshtuter Allee 12-14
80637 Munich, Germany

Tegangan dan Frekuensi:
C1: 200-240V ~ 50/60Hz
C2: 100-240V ~ 50/60Hz (PROYEKTOR CATU DAYA)
200-240V ~ 50/60Hz (CAHAYA CATU DAYA)

Produksi China

THIS CABINET IS CONSTRUCTED OF METAL(AL)

⚠ 警告	⚠ 高圧注意	使用上の注意
	サービスマン以外の方は外装パネルを外さないでください。内部には高電圧部分が多くあり、万一さわると危険です。	イ。通風孔をふさがしないでください。内部温度の上昇を招き故障の原因になります。口。温度の高い場所や湿気の多い場所での使用は避けてください。

CAUTION: TO PREVENT ELECTRIC SHOCK, DO NOT OPEN TOP COVER. NO USER-SERVICEABLE PARTS INSIDE.
ATTENTION: AFIN DE PREVENIR UN CHOC ELECTRIQUE, NE PAS ENLEVER LE COUVERCLE.S'ADRESSER A UN REPARATEUR COMPETENT.
ВНИМАНИЕ: ВО ИЗБЕЖАНИЕ УДАРА ЭЛЕКТРИЧЕСКИМ ТОКОМ НЕ ОТКРЫВАЙТЕ ВЕРХНЮЮ КРЫШКУ. ВНУТРИ НЕТ ДЕТАЛЕЙ, ОБСЛУЖИВАЕМЫХ ПОЛЬЗОВАТЕЛЕМ.
주의: 전기충격 방지를 위해 캐비닛을 열지 마십시오. 내부에는 사용자를 위한 서비스가능 부품이 들어있지 않습니다.
ACHTUNG: Zur Vermeidung eines elektrischen Schlages, öffnen Sie das Gehäuse nicht selbst. In diesem Gerät sind keine Teile enthalten, die vom Nutzer gewartet werden können, ZUR TRENNUNG VOM NETZ IST DER NETZSTECKER AUS DER STECKDOSE ZU ZIEHEN!
注意: 請勿打開頂蓋・小心高壓電擊・機內並無用戶配件・

この装置は、クラスA機器です。この装置を住宅環境で使用すると電波妨害を引き起こすことがあります。この場合には使用者が適切な対策を講ずるよう要求されることがあります。 VCCI-A

警告使用者: 此為甲類資訊技術設備。於居住環境中使用時。可能會造成射頻擾動。在此種情況下。使用者會被要求採取某些適當的對策。

THIS DEVICE COMPIES WITH PART 15 OF THE FCC RULES. OPERATION IS SUBJECT TO THE FOLLOWING TWO CONDITIONS:
 (1) THIS DEVICE MAY NOT CAUSE HARMFUL INTERFERENCE, AND
 (2) THIS DEVICE MUST ACCEPT ANY INTERFERENCE RECEIVED, INCLUDING INTERFERENCE THAT MAY CAUSE UNDESIRABLE OPERATION.
 CAN ICES-3(A)/NMB-3(A)

Проектор
 Модель: NP-NC2002ML
 C1: 200-240В ~ 50/60Гц, 18.1А
 C2: 100-240В ~ 50/60Гц, 6.0А Проектор Мощность
 200-240В ~ 50/60Гц, 15.2А Света Мощность
 Сделано в Китае
 Производитель: Дельта Электроникс, Инк.

10

Label C (NP-NC2003ML)

NEC MODEL No. NP-NC2003ML C1: 200-240V ~ 50/60Hz 18.1A
 C2: 100-240V ~ 50/60Hz 6.0A for PJ POWER
 200-240V ~ 50/60Hz 15.2A for LIGHT POWER

XXXX XXXX
3264668800

Sharp NEC Display Solutions, Ltd. Contact address for EMEA Tegangan dan Frekuensi:
 4-28, Mita 1-chome, Minato-ku, Tokyo, Japan Sharp NEC Display Solutions Europe GmbH C1: 200-240V ~ 50/60Hz
 MADE IN CHINA Landshter Allee 12-14 C2: 100-240V ~ 50/60Hz(PROYEKTOR CATU DAYA)
 80637 Munich, Germany 200-240V ~ 50/60Hz(CAHAYA CATU DAYA)
 Produksi China

THIS CABINET IS CONSTRUCTED OF METAL(AL)

警告	高圧注意	使用上の注意 イ、通風孔をふさがしないでください。内部温度の上昇を招き故障の原因になります。口、温度の高い場所や湿気の高い場所での使用はさけてください。
	サービスマン以外の方は外装パネルを外さないでください。内部には高電圧部分が多くあり、万一さわると危険です。	

CAUTION: TO PREVENT ELECTRIC SHOCK, DO NOT OPEN TOP COVER. NO USER-SERVICEABLE PARTS INSIDE.
ATTENTION: AFIN DE PREVENIR UN CHOC ELECTRIQUE, NE PAS ENLEVER LE COUVERCLE.S'ADRESSER A UN REPARATEUR COMPETENT.
ВНИМАНИЕ: ВО ИЗБЕЖАНИЕ УДАРА ЭЛЕКТРИЧЕСКИМ ТОКОМ НЕ ОТКРЫВАЙТЕ ВЕРХНЮЮ КРЫШКУ. ВНУТРИ НЕТ ДЕТАЛЕЙ, ОБСЛУЖИВАЕМЫХ ПОЛЬЗОВАТЕЛЕМ.
주의: 전기충격 방지를 위해 캐비닛을 열지 마십시오. 내부에는 사용자를 위한 서비스가능 부품이 들어있지 않습니다.
ACHTUNG: Zur Vermeidung eines elektrischen Schläges, öffnen Sie das Gehäuse nicht selbst. In diesem Gerät sind keine Teile enthalten, die vom Nutzer gewartet werden können. ZUR TRENNUNG VOM NETZ IST DER NETZSTECKER AUS DER STECKDOSE ZU ZIEHEN!
注意: 請勿打開頂蓋・小心高壓電擊・機內並無用戶配件。

この装置は、クラスA機器です。この装置を住宅環境で使用すると電波妨害を引き起こすことがあります。この場合には使用者が適切な対策を講ずるよう要求されることがあります。 VCCI-A

警告使用者: 此為甲類資訊技術設備, 於居住環境中使用時, 可能造成射頻擾動。在此種情況下, 使用者會被要求採取某些適當的對策。

THIS DEVICE COMPLIES WITH PART 15 OF THE FCC RULES. OPERATION IS SUBJECT TO THE FOLLOWING TWO CONDITIONS:
 (1) THIS DEVICE MAY NOT CAUSE HARMFUL INTERFERENCE, AND
 (2) THIS DEVICE MUST ACCEPT ANY INTERFERENCE RECEIVED, INCLUDING INTERFERENCE THAT MAY CAUSE UNDESIRE OPERATION. CAN ICES-003(A)/NMB-003(A)

Проектор
 Модель: NP-NC2003ML
 C1: 200-240В ~ 50/60Гц, 18.1А
 C2: 100-240В ~ 50/60Гц, 6.0А Проектор Мощность
 200-240В ~ 50/60Гц, 15.2А Света Мощность
 Сделано в Китае
 Производитель: Дельта Электроникс, Инк.

This product complies with performance standards for laser products under 21 CFR Part 1040 except with respect to those characteristics authorized by Variance Number 2015-W-3435 effective on April 7, 2016.

Label C (NP-NC1802ML)

NEC MODEL No. NP-NC1802ML C1: 200-240V ~ 50/60Hz 18.1A
 C2: 100-240V ~ 50/60Hz 6.0A for PJ POWER
 200-240V ~ 50/60Hz 15.2A for LIGHT POWER

XXXX XXXX
3264654401

Sharp NEC Display Solutions, Ltd. Contact address for EMEA Tegangan dan Frekuensi:
 4-28, Mita 1-chome, Minato-ku, Tokyo, Japan Sharp NEC Display Solutions Europe GmbH C1: 200-240V ~ 50/60Hz
 MADE IN CHINA Landshter Allee 12-14 C2: 100-240V ~ 50/60Hz(PROYEKTOR CATU DAYA)
 80637 Munich, Germany 200-240V ~ 50/60Hz(CAHAYA CATU DAYA)
 Produksi China

THIS CABINET IS CONSTRUCTED OF METAL(AL)

警告	高圧注意	使用上の注意 イ、通風孔をふさがしないでください。内部温度の上昇を招き故障の原因になります。口、温度の高い場所や湿気の高い場所での使用はさけてください。
	サービスマン以外の方は外装パネルを外さないでください。内部には高電圧部分が多くあり、万一さわると危険です。	

CAUTION: TO PREVENT ELECTRIC SHOCK, DO NOT OPEN TOP COVER. NO USER-SERVICEABLE PARTS INSIDE.
ATTENTION: AFIN DE PREVENIR UN CHOC ELECTRIQUE, NE PAS ENLEVER LE COUVERCLE.S'ADRESSER A UN REPARATEUR COMPETENT.
ВНИМАНИЕ: ВО ИЗБЕЖАНИЕ УДАРА ЭЛЕКТРИЧЕСКИМ ТОКОМ НЕ ОТКРЫВАЙТЕ ВЕРХНЮЮ КРЫШКУ. ВНУТРИ НЕТ ДЕТАЛЕЙ, ОБСЛУЖИВАЕМЫХ ПОЛЬЗОВАТЕЛЕМ.
주의: 전기충격 방지를 위해 캐비닛을 열지 마십시오. 내부에는 사용자를 위한 서비스가능 부품이 들어있지 않습니다.
ACHTUNG: Zur Vermeidung eines elektrischen Schläges, öffnen Sie das Gehäuse nicht selbst. In diesem Gerät sind keine Teile enthalten, die vom Nutzer gewartet werden können. ZUR TRENNUNG VOM NETZ IST DER NETZSTECKER AUS DER STECKDOSE ZU ZIEHEN!
注意: 請勿打開頂蓋・小心高壓電擊・機內並無用戶配件。

この装置は、クラスA機器です。この装置を住宅環境で使用すると電波妨害を引き起こすことがあります。この場合には使用者が適切な対策を講ずるよう要求されることがあります。 VCCI-A

警告使用者: 此為甲類資訊技術設備, 於居住環境中使用時, 可能造成射頻擾動。在此種情況下, 使用者會被要求採取某些適當的對策。

THIS DEVICE COMPLIES WITH PART 15 OF THE FCC RULES. OPERATION IS SUBJECT TO THE FOLLOWING TWO CONDITIONS:
 (1) THIS DEVICE MAY NOT CAUSE HARMFUL INTERFERENCE, AND
 (2) THIS DEVICE MUST ACCEPT ANY INTERFERENCE RECEIVED, INCLUDING INTERFERENCE THAT MAY CAUSE UNDESIRE OPERATION. CAN ICES-3(A)/NMB-3(A)

Проектор
 Модель NP-NC1802ML
 C1: 200-240В ~ 50/60Гц, 18.1А
 C2: 100-240В ~ 50/60Гц, 6.0А Проектор Мощность
 200-240В ~ 50/60Гц, 15.2А Света Мощность
 Сделано в Китае
 Производитель: Дельта Электроникс, Инк.

商品名稱: 投影機 型號: NP-NC1802ML
 電源 / 額定輸入電流:
 C1: 200-240V ~ 50/60Hz 18.1A
 C2: 100-240V ~ 50/60Hz 6.0A (投影機 電源)
 200-240V ~ 50/60Hz 15.2A (光 電源)
 生產國別: 中國

제품명: 프로젝터
 모델명: NP-NC1802ML
 제조/국가: 델타 일렉트로닉스 (강주) 유한회사 / 중국
 입력전력:
 C1: 200-240V ~ 50/60Hz, 18.1A
 C2: 100-240V ~ 50/60Hz, 6.0A (프로젝터 전원)
 200-240V ~ 50/60Hz, 15.2A (빛 전원)
 생산일: 일련번호에 표기
 인증 서비스 센터 전화 번호:
 080-022-1155 (호스팅주식회사)
 *본 라벨과 전화번호는 국내 규정 내에서 적절한 목적으 로만 사용되어야 합니다.

ZU19002-19006
 R-0017P-NP-0218D

This product complies with performance standards for laser products under 21 CFR Part 1040 except with respect to those characteristics authorized by Variance Number 2015-W-3435 effective on April 7, 2016.

Important Information

Label C (NP-NC1803ML)

MODEL No. NP-NC1803ML

C1: 200-240V ~ 50/60Hz 18.1A
C2: 100-240V ~ 50/60Hz 6.0A for PJ POWER
200-240V ~ 50/60Hz 15.2A for LIGHT POWER

XXXX XXXX
3264668900

Sharp NEC Display Solutions, Ltd.
4-28, Mita 1-chome, Minato-ku, Tokyo, Japan

MADE IN CHINA

Contact address for EMEA
Sharp NEC Display Solutions Europe GmbH
Landshuter Allee 12-14
80637 Munich, Germany

Tegangan dan Frekuensi:
C1: 200-240V ~ 50/60Hz
C2: 100-240V ~ 50/60Hz (PROYEKTOR CATU DAYA)
200-240V ~ 50/60Hz (CAHAYA CATU DAYA)
Produksi China

THIS CABINET IS CONSTRUCTED OF METAL(AL)

⚠ 警告	高压注意		使用上の注意
	サービスマン以外の方は外装パネルを外さないでください。 内部には高電圧部分が多くあり、万一さわると危険です。		イ。通風孔をふさがらないでください。内部温度の上昇を招き故障の原因になります。 ロ。温度の高い場所や湿気の多い場所での使用はさけてください。

CAUTION: TO PREVENT ELECTRIC SHOCK, DO NOT OPEN TOP COVER. NO USER-SERVICEABLE PARTS INSIDE.
ATTENTION: AFIN DE PREVENIR UN CHOC ELECTRIQUE, NE PAS ENLEVER LE COUVERCLE.S'ADRESSER A UN REPARATEUR COMPETENT.
ВНИМАНИЕ: ВО ИЗБЕЖАНИЕ УДАРА ЭЛЕКТРИЧЕСКИМ ТОКОМ НЕ ОТКРЫВАЙТЕ ВЕРХНЮЮ КРЫШКУ.
ВНУТРИ НЕТ ДЕТАЛЕЙ, ОБСЛУЖИВАЕМЫХ ПОЛЬЗОВАТЕЛЕМ.
주의: 전기충격 방지를 위해 캐비닛을 열지 마십시오. 내부에는 사용자를 위한 서비스가능 부품이 들어있지 않습니다.
ACHTUNG: Zur Vermeidung eines elektrischen Schlages, öffnen Sie das Gehäuse nicht selbst.
In diesem Gerät sind keine Teile enthalten, die vom Nutzer gewartet werden können.
ZUR TRENNUNG VOM NETZ IST DER NETZSTECKER AUS DER STECKDOSE ZU ZIEHEN!
注意: 請勿打開頂蓋・小心高壓電擊・機內並無用戶配件・

この装置は、クラスA 機器です。この装置を住宅環境で使用すると電波妨害を引き起こすことがあります。 この場合には使用者が適切な対策を講ずるよう要求されることがあります。	警告使用者: 此為甲類資訊技術設備。於居住環境中使用時。可能會造成射頻擾動。 在此種情況下。使用者會被要求採取某些適當的對策。
---	--

THIS DEVICE COMPLIES WITH PART 15 OF THE FCC RULES. OPERATION IS SUBJECT TO THE FOLLOWING TWO CONDITIONS:
(1)THIS DEVICE MAY NOT CAUSE HARMFUL INTERFERENCE, AND
(2)THIS DEVICE MUST ACCEPT ANY INTERFERENCE RECEIVED, INCLUDING INTERFERENCE THAT MAY CAUSE UNDESIRE OPERATION.
CAN ICES-003(A)/NMB-003(A)

This product complies with performance standards for Laser products under 21 CFR Part 1040 except with respect to those characteristics authorized by Variance Number 2015-4-3435 effective on April 7, 2016.

Проектор
 Модель : NP-NC1803ML
 C1:200-240В ~, 50/60Гц,18.1А Проектор Мощность
 C2:100-240В ~, 50/60Гц, 6.0А Проектор Мощность
 200-240В ~, 50/60Гц,15.2А Света Мощность
 Сделано в Китае
 Производитель: Дельта Электроникс, Инк.

Label D

MODEL NO. NP-XXXXXXXX XXXXXXXX

Label E

M/F Date : YYYY. MM. DD

12

Laser radiation range/No entry range (HD: Hazard distance)

- The below table describes the radiation range of emitted light by the projector that is classified as Risk Group 3 (RG3) in the IEC 62471-5 First edition 2015.
- The below table describes the radiation range of emitted light by the projector that is classified as Risk Group 3 (RG3) in the IEC 62471:2006.(for USA).
- Please keep within bounds for installing the projector.
 Install a barrier for preventing human eyes from entering the RG3 area.For the barrier installation position, keep horizontal safety zone over 1m from the RG3 area.In case to install the projector over head, keep over 2m (2.5m for USA) distance at least between the floor surface and the RG3 area.
 Operators shall control access to the beam within the hazard distance or install the product at the height that will prevent exposures of spectators' eyes within the hazard distance.

NP-02HD/NP-NC2402ML/NP-NC2002ML/NP-NC1802ML/NP-NC2403ML/NP-NC2003ML/NP-NC1803ML

(IEC 62471-5 First edition 2015)

Lens		RG3 HD(m)	Screen size(m)	
			H	V
NC-60LS12ZW	Wide	1.7	1.49	0.79
	Tele	2.7	1.50	0.79
NC-60LS12Z	Wide	1.5	1.28	0.67
	Tele	2.6	1.48	0.78
NC-60LS14Z	Wide	2.0	1.49	0.78
	Tele	3.0	1.51	0.80
NC-60LS16Z	Wide	2.2	1.42	0.75
	Tele	3.9	1.59	0.84
NC-60LS19Z	Wide	2.8	1.40	0.74
	Tele	4.8	1.44	0.76
NC-60LS24Z	Wide	3.6	1.43	0.76
	Tele	5.8	1.46	0.77
NC-60LS39Z	Wide	5.9	1.47	0.77
	Tele	9.9	1.50	0.79

(IEC 62471:2006 (for USA))

Lens		RG3 HD(m)	Screen size(m)		EHv
			H	V	
NC-60LS12ZW	Wide	2.3	1.97	1.04	8.7
	Tele	3.5	1.98	1.04	12.9
NC-60LS12Z	Wide	1.9	1.69	0.89	6.9
	Tele	3.5	1.95	1.03	11.9
NC-60LS14Z	Wide	2.7	1.96	1.04	9.9
	Tele	4.0	1.99	1.05	14.3
NC-60LS16Z	Wide	2.9	1.87	0.99	10.1
	Tele	5.2	2.10	1.11	17.4
NC-60LS19Z	Wide	3.7	1.89	1.00	11.3
	Tele	6.4	1.93	1.02	16.0
NC-60LS24Z	Wide	4.7	1.93	1.02	14.7
	Tele	7.7	1.95	1.03	19.6
NC-60LS39Z	Wide	7.8	1.97	1.04	21.6
	Tele	13.1	2.00	1.06	29.9

When installed on a floor or a desktop

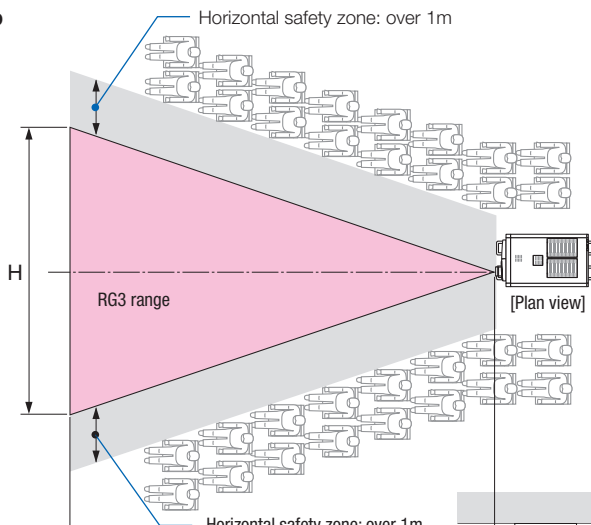

When installed on a ceiling

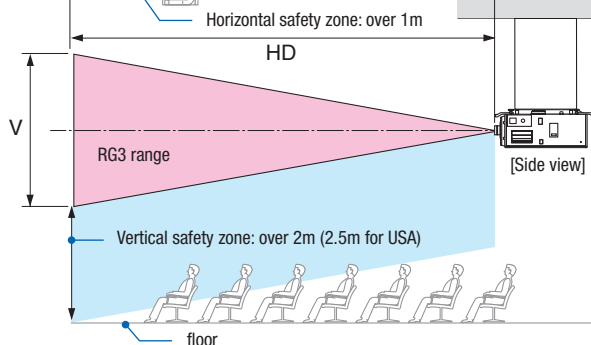

* If lens shift is utilized, please consider the shift of projected image according to the volume of lens shift.

Important Information



CAUTION

Please heed all precaution for safety.

To install the projector

- For planning the layout of the projector, make sure to take safety measures instructed on the installation manual.
- In order to refuse danger, install either a wall outlet within easy reach for pulling out the power plug in emergency or a device as a breaker to shut down the power supply to the projector.
- Take safety measures preventing human eyes from entering the RG3 area.
- Considering the installation place, select an appropriate lens and secure safety zone that is determined for each lens. For operation on the powered projector as light adjustment, make sure appropriate safety measures have been taken.
- Check the validity of taken security measures if appropriate safety zone based on the installed lens is secured. Periodically check the validity and keep these results.
- Educate the administrator of the projector (operators) about safety before starting to operate the projector.
- This projector is an RG3 product. The projector is for professional use and must be installed in location where safety is assured. For this reason, be sure to consult your dealer as installation and attachment/detachment of the lens unit must be performed by a professional service personnel. Never try to install the projector by yourself. This may result in visual impairment etc.

To use the projector

- Instruct the administrator of the projector (operators) to perform inspections before powering on the projector. (Including the safety check against emitted light by the projector)
- Instruct the administrator of the projector (operators) to be in circumstances able to control the projector whenever the projector is powered on for an emergency.
- Instruct the administrator of the projector (operators) to keep the installation manual, user's manual and inspection records to a place where they can take these documents out easily.
- Instruct them to clarify if the projector is conformed to standards of each country and region.

Table of Contents

Important Information	2
1. What's in the Box? and the Names of the Projector Parts.....	17
1-1. Features.....	17
1-2. What's in the Box?	19
1-3. Names of the Projector Parts	20
2. Installation and Connection.....	26
2-1. Steps for setting up and connecting.....	26
2-2. Connecting the Power Cable	27
2-3. Connecting the image input terminals.....	32
2-4. Connecting the various control terminal	32
3. Projection of Images (Basic Operation).....	33
3-1. Steps of projecting images.....	33
3-2. Turning your projector on	34
3-3. Selecting the title of input signal.....	36
3-4. Adjusting the position and the size of projected screen.....	37
3-5. Preventing misoperations.....	41
3-6. Turning on/off the light with the projector turned on.....	42
3-7. Turning your projector off	43
4. Using Menus	45
4-1. Basic operation with adjustment menus	45
4-2. Table of adjustment menus	50
4-3. Title Select.....	52
4-4. Configuration.....	53
4-5. Title Setup	55
4-6. Information	55
5. Maintenance of Your Projector	59
5-1. Cleaning the Cabinet	59
5-2. Cleaning the Lens	60
5-3. Cleaning the Air Filters.....	60

6. Appendix 63

- 6-1. Troubleshooting63
- 6-2. Indicator display list.....64
- 6-3. Operation using an HTTP browser67
- 6-4. Writing of the log file (Save Information).....69
- 6-5. Outline Drawing.....72
- 6-6. Specifications.....73
- 6-7. Pin Assignment and Functions of Terminal74
- 6-8. Related products list.....81

1.

What's in the Box? and the Names of the Projector Parts

1-1. Features

- **DLP Cinema® projector**

Complies with the strict projection standards defined by the Digital Cinema Initiatives (DCI) industry group in the United States using leading imaging technology of NEC. It also supports 3D projection and high frame rates (HFR).

- **Employs a long life laser light source**

The projector employs a newly developed laser light source offering excellent reliability and redundancy. Since the laser light source has a long life (approx. 30,000 hours), this delivers low cost operation by removing the need for maintenance such as replacing and adjusting the light module over extended periods of time. Furthermore, it reduces the risk of the light source suddenly shutting off and leaving a black screen.

- **Delivers reduced installation space and increased freedom through a more compact and lightweight body**

The use of a 0.98" DLP cinema chip together with integration of the light module into the projector main unit both delivers a reduced installation area as well as improving the degree of freedom of installation, such as removing the need to connect to external ventilation ducting and supporting both pedestal-mounted and ceiling-suspended installation. A wide variety of optional lenses (sold separately) are also available for the projector in order to support a wide variety of installation methods (a lens is not mounted when the projector is shipped from the factory).

- **Equipped with easy to use functions**

(1) Lens memory function and light memory function that can be operated with one touch.

The projector is equipped with a lens memory function that can save the zoom position and shift position of the lens and a light memory function that can save the brightness setting separately for each input signal. This makes it possible to project using preconfigured settings simply by selecting the signal when projecting multiple different input signals each with different screen size and brightness settings (Refer to "6-8. Related products list" (page 81) for details on the lenses that support the lens memory function).

(2) Built-in automatic adjustment function that makes the brightness and color of the light source uniform

Degradation of brightness and variations in color that occur as the light source is used for longer periods of time are kept to a minimum (the period over which variations in brightness can be limited varies depending on the brightness setting).

1. What's in the Box? and the Names of the Projector Parts

(3) Frequently used titles can be registered in preset buttons

The projector has been equipped with 8 preset buttons that make it easy to select registered title (input signal). To this projector, 100 titles at most can be registered (input signal registration). Among the registered titles, any 16 titles can be assigned to the preset buttons.

(4) You can operate and configure the projector via a network from a PC

You can operate and configure the projector via a network from a PC by using the separately supplied software Digital Cinema Communicator (DCC) v2.

- **Excellent dust-proof performance**

A circulating cooling system is used to cool the optical components. The system converts warm air into cold air and circulates it inside a sealed structure, so external air does not come into contact with the optical components. This prevents dust and dirt from getting on the optical components, maintaining brightness.

* Note that dust and dirt cannot be completely shut out.

- **Reduced running cost thanks to the use of metal filters**

The filters are made of metal, so they can be used repeatedly and do not have to be replaced when performing periodic cleaning. This not only reduces running costs, but also contributes to preserving the environment since no spent filters are discarded.

1-2. What's in the Box?

Check the content of the accessories.

1-2-1. Projector

Projector

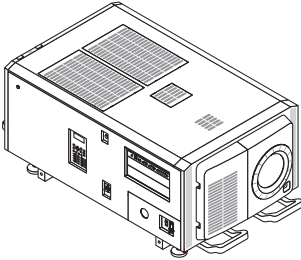

Service door key x 2

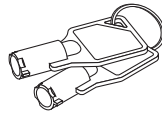

Keys for administrator x 2

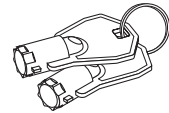
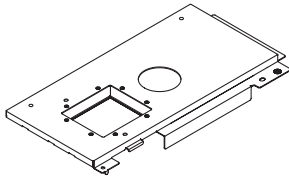
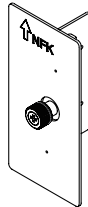

Plate Inlet $\phi 35$



NFK



NFK-G18*1

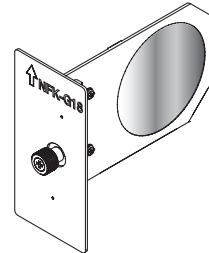

M5 x L20 light module fixing screws x 2 *2

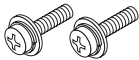

Power cable stopper

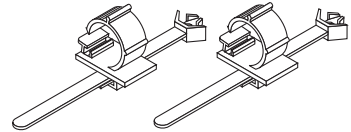

CD-ROM (User's Manual)

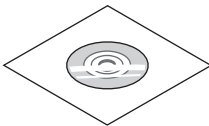

Important Information

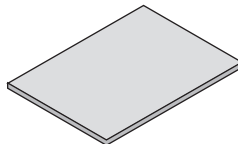

*1 NFK-G24 is packaged with NP-NC1802ML/NP-NC1803ML.

*2 NP-02HD only.

TIP In the event that you did not receive all of the accessories outlined above, or some are damaged, contact your dealer/distributor.
Differs slightly from the drawings in this manual, but there is no problem in actual use.

1-3. Names of the Projector Parts

1-3-1. Front of the projector

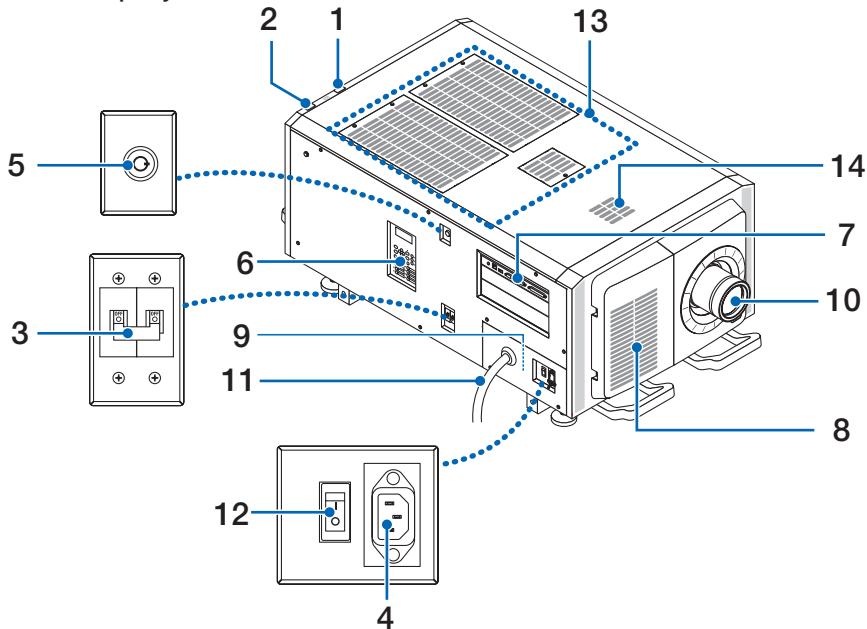

1. LIGHT status indicator

Displays the status of the light source. The indicators turn on when the light source is on and turn off when the light source is off (See page 66).

2. SYSTEM status indicator

These indicate the status of the projector. When the projector is operating normally, these light/blink in green or orange. When an error occurs, they light/blink in red. When an error occurs, check the contents of the display on the LCD screen. (See page 66)

3. Light power switch

While AC power is being supplied, set the projector power switch and light power switch to ON position, then your projector will enter a standby state.

4. AC input

Connects to the AC power cable. The AC power cable is not an accessory. Consult with your dealer/distributor about the AC power cable.

5. Switch for administrator

The projector can be operated normally by inserting the administrator key horizontally and turning it clockwise to the vertical position.

At this time, the administrator key cannot be removed. The projector will not function unless the administrator key is inserted.

6. Control panel

On the control panel, power to your projector is turned on or off, titles are selected, and various adjustments are made of projected screen. (See page 24)

7. Connection terminals

Various image signal cable are to be connected here. (See page 23)

You can expand signal input terminals by installing the optional board.

Contact your dealer/distributor for more information on separately sold optional products.

8. Air inlet

The air inlet for cooling inside the projector. Do not cover.

Air filters are provided on the air intakes to prevent dust from entering the projector.

9. Remote interlock connector (inside the main unit's side panel)

This port is for safely using the laser in this device. It is used to externally control the laser illumination in the projector. Consult with your dealer/distributor about using this.

10. Lens (optional)

Images are projected from the lens. Request your dealer/distributor to install or replace the lens.

11. AC power cord

This cord supplies AC power to the projector. Please contact your dealer/distributor for connection of the AC power cord.

12. Projector power switch

When the light power switch and projector power switch are turned on with AC power supplied, the projector is set to the standby mode.

13. Air intake

These are air intake ports for introducing external air to reduce the temperature inside the projector. Do not block the port. Air filters are provided on the air intakes to prevent dust from entering the projector.

14. Exhaust port

The heat inside the projector is expelled from here. Do not block the port.

NOTE Do not cover the air inlets and outlet while the projector is in operation. Insufficient ventilation leads to a rise of the internal temperature and may cause a fire or malfunction.

1-3-2. Rear of the projector

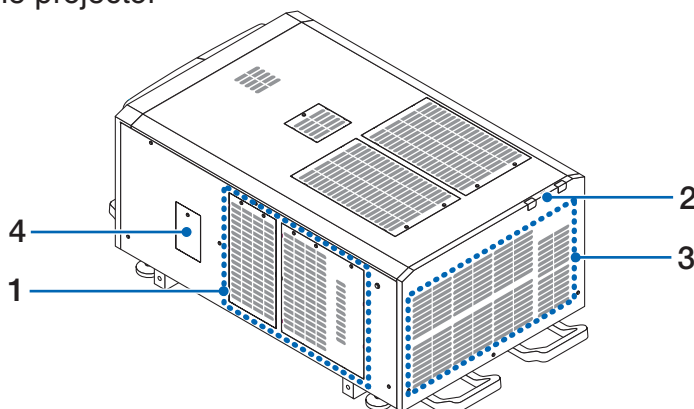

1. Air inlet

The air inlet for cooling inside the projector. Do not cover.

2. Buzzer (inside rear of projector)

The buzzer rings when the power is turned on or an error has occurred.

3. Air outlet

The air outlet to exhaust heat inside the projector. Do not cover.

4. Notch filter cover

Remove the cover when installing the notch filter. Contact your dealer/distributor for details on replacement notch filters.

NOTE Do not cover the air inlets and outlet while the projector is in operation. Insufficient ventilation leads to a rise of the internal temperature and may cause a fire or malfunction.

1-3-3. Bottom of the projector

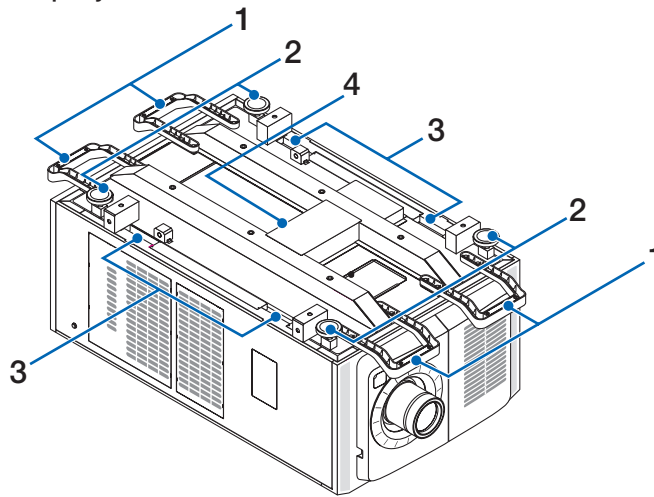

1. Handle (4 locations)

Handles for moving the projector.

2. Level adjusters (in 4 positions)

In the ordinary installation, you can adjust the projector inclination at 4 positions.

3. Grips

These grips are used when moving the projector.

4. Exhaust port

The heat inside the projector is expelled from here. Do not block the port.

1-3-4. Connection terminals

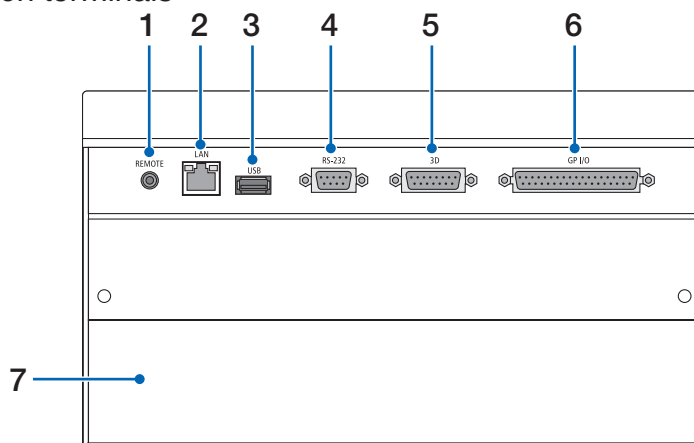

1. Service terminal (REMOTE) (Stereo mini)

This terminal is used for service purpose only.

2. Ethernet port (LAN) (RJ-45)

The port for interfacing with an image signal server or controlling the projector from a PC via a network. Connect the projector and the PC with a commercially available Ethernet cable (10/100/1000Base-T).

3. USB port (USB) (type A)

The port for the projector maintenance.

4. PC control terminal (RS-232) (D-sub 9P)

The terminal for operating the projector from a PC via an RS-232C or for service personnel to set data for the projector. Connect the projector and the PC with a commercially available RS-232C straight cable.

5. 3D terminal (3D) (D-sub 15P)

The terminal for connecting a 3D image system to the projector. (See page 80)

6. External control terminal (GP I/O) (D-sub 37P)

The terminal for externally controlling the projector or connecting a 3D image system to the projector. (See page 75)

7. Slot

The slot is used for an image media block (IMB). Contact your dealer/distributor for an installation of IMB.

Refer to the IMB instruction manual for details on IMB.

1-3-5. Control panel

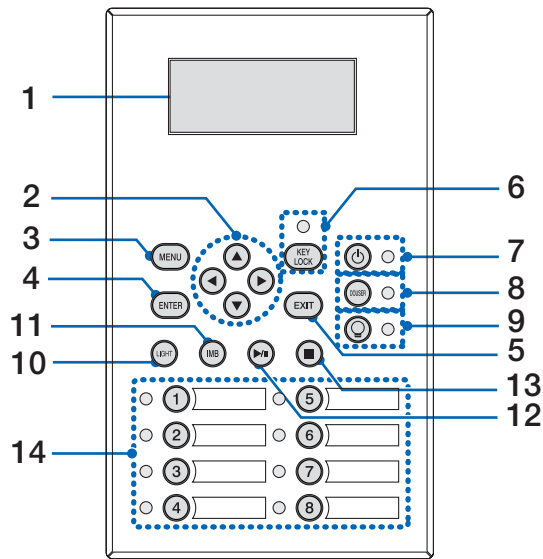

1. LCD screen

The LCD screen displays menus and setting values for the projector operations.

2. ▲/▼/◀/▶ (UP/DOWN/LEFT/RIGHT) buttons

Press these buttons to select a menu item while a menu is displayed.

3. MENU button

Press this button to display the menu for various settings and adjustments. (See page 50)

4. ENTER button

Press this button to select the menu item.

5. EXIT button

Press this button to return to the previous menu item.

6. KEY LOCK button

Press this button to lock (KEY LOCK) the buttons on the control panel. Buttons on the control panel do not function while KEY LOCK is on.

Pressing the KEY LOCK button for one second or longer while KEY LOCK is off locks the buttons.

Pressing the KEY LOCK button for one second or longer while KEY LOCK is on unlocks the buttons. (See page 41)

NOTE KEY LOCK becomes automatically on if no control panel operation takes place in the standby state for 30 seconds by default. (See page 41)

7. ⏻ button (POWER button)

Press this button for more than three seconds to turn on or off (standby) the projector. (See page 65)

In order to start up the projector, turn on the main power switch for the projector to set the projector in the standby state. (See page 34)

8. DOUSER button

Press this button to open and close the douser. (See page 65)

9. ☀️ button (LIGHT ON/OFF button)

Press this button for five seconds or longer to turn on or off the light source while the projector is on. (See page 42)

10. LIGHT button

Press this button to display the light source adjustment menu. (See page 40)

11. IMB button (planned to be supported in a future update)

This button is operable when the media block is installed in the projector.

Press this button to display the operation menu of the media block.

12. Play/pause button (planned to be supported in a future update)

This button is operable when the media block is installed in the projector.
Press this button to play or pause the image contents.

13. Stop button (planned to be supported in a future update)

This button is operable when the media block is installed in the projector.
Press this button to stop playing the image contents.

14. Preset buttons

Press the preset button to select a title (input signal) assigned to each button. Up to 100 titles (input signals) can be registered to this projector, and any 16 titles from them can be assigned to the preset button. Please request your dealer to register and change the titles of the buttons as required.

The preset button indicators show their assigned title or selection status. (See page 64)



TIP

To select a title allocated to one of the preset buttons, use the following procedure.

- To select a title allocated to one of "Preset Button1" to "Preset Button8"
Press the button which corresponds to the number of the preset button (button <1> to <8>).
 - Press the <1> button to select the "Preset Button1".
 - Press the <8> button to select the "Preset Button8".
- To select a title allocated to one of "Preset Button9" to "Preset Button16"
Press the preset button (button <1> to <8>) while holding down the UP button.
 - Press the <1> button while holding down the UP button to select the "Preset Button9".
 - Press the <8> button while holding down the UP button to select the "Preset Button16".



2.

Installation and Connection

2-1. Steps for setting up and connecting

Use the following steps for setting up your projector:

- **Step 1**

Setup the screen and projector. (Contact your dealer to carry out the setup.)

- **Step 2**

Connect the power cable to the projector. (See page [27](#))

- **Step 3**

Connect cables to the image input terminals. (See page [32](#))

Connect cables to the various control terminals. (See page [32](#))

2-2. Connecting the Power Cable

Consult your dealer for installing the power cable to the projector.

If AC power is supplied to the projector and light with one power cable (C1 connection), it is not necessary to connect the cable to the projector power supply.

The power cable is not included with the projector. Use a power cable that meets the standards and power supply voltage of the country where you are using the projector. Ask your dealer for the power cable to select and purchase.

WARNING

Carefully read the contents described in this section before connection and connect the cables according to the proper procedure. Inappropriate handling may cause fatal, serious or other bodily injuries due to fire or electric shock.

WARNING

- Consult your dealer for installing the power cable to the projector.
DO NOT install the power cable by yourself. Doing so may cause a fire or electric shock.
- Before connecting the power cables, check that the projector power switch and light power switch of the projector is turned off. Implement the connection with AC power shut off.
- Be sure to ground the equipment to ensure safety. Use a power cable that meets the standards and power supply voltage of the country where you are using the projector, and always connect the equipment to the ground. If the ground is not connected, it may cause electrical shocks.
- When connecting the power cable plugs to the AC IN and the electrical outlet, securely insert the plugs all the way in.
- For C2 connection, be sure to install the power cord stopper. If the connection between the power cable plug and the electrical outlet is loose, the plug area may generate heat, causing burns and accidents.

CAUTION

- This equipment is designed to be used in the condition of the power cord connected to earth. If the power cord is not connected to the earth, it may cause electric shock. Please make sure the power cord is earthed properly.

2. Installation and Connection

1 Connect the AC power supply cable.

Connect the AC power supply cable to the projector.

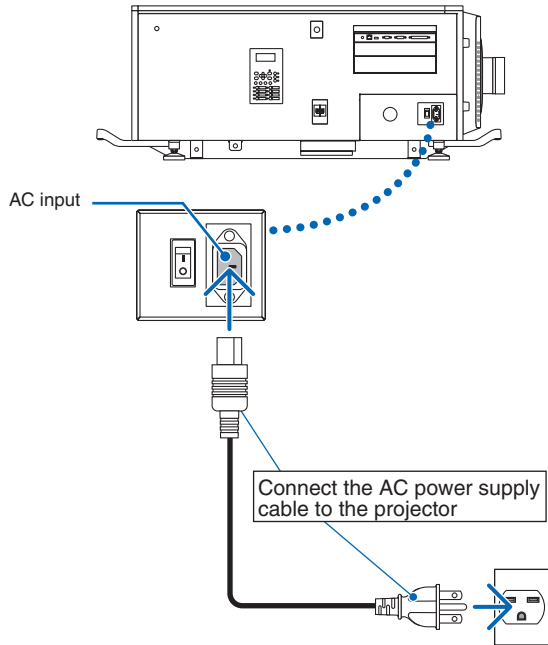

2 Connect the power plug to the electrical outlet.

This completes the connection of the AC power supply cable.

Attaching the power cable stopper

To prevent the power cable from accidentally removing from the AC IN of the projector, attach the supplied power cable stopper to clamp the power cable.

CAUTION

- To prevent the power cable from coming loose, make sure that all the prongs of the power cable are fully inserted into the AC IN terminal of the projector before using the power cable stopper to fix the power cable. A loose contact of the power cable may cause a fire or electric shock.
- Do not bundle the power cable. Doing this could cause heat or a fire.

NOTE

- Do not clamp the power cable with other cables. Doing so can generate noise, which can affect adversely the signal cable.
- Be careful not to insert the band inversely. Once the band is attached, it cannot be removed from the slot.

- 1** With the band of the clammer unit facing the power supply cord, line up the tip of the power supply cord stopper with the mounting hole in the projector body and press in.

Attach the power cord stopper on the opposite side in the same way.

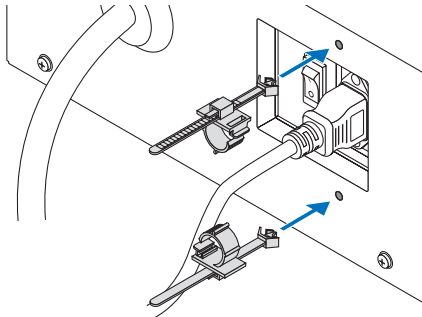

- 2** Pass the band through the slits in the power cord stoppers.

Use the two bands to wrap the power cord from the left and right sides.

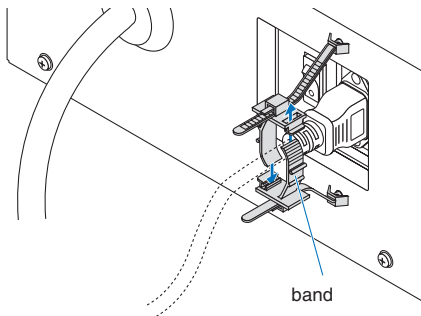

2. Installation and Connection

3 Slide the clamber unit to the base of the power cord.

The position of the clamber unit can be adjusted by pulling the tab in the direction of the arrow. After adjusting the position of the clamber unit, release the tab to fix the clamber unit in place.

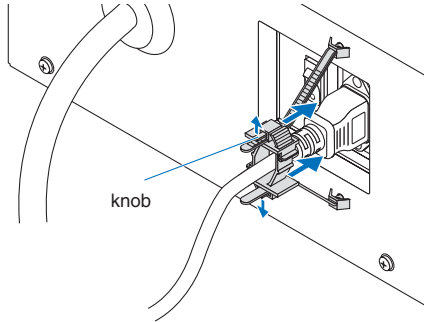

4 Pull the band to fasten the power cord.

The position of the band can be adjusted by pulling the tab in the direction of the arrow. Pull the upper and lower sections of the band in a well-balanced manner. After adjusting the position of the band, release the tab to fix the band in place.

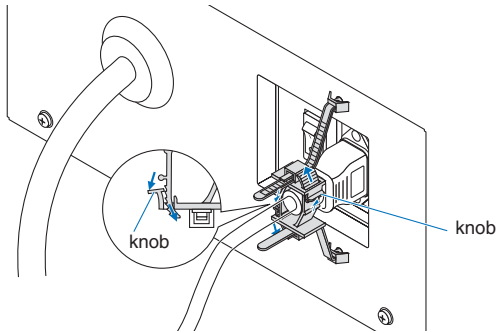

This completes the attachment of the power cable stopper.

Removing the power cable from the power cable stopper

Pull the knob of each clamber to remove the two bands.

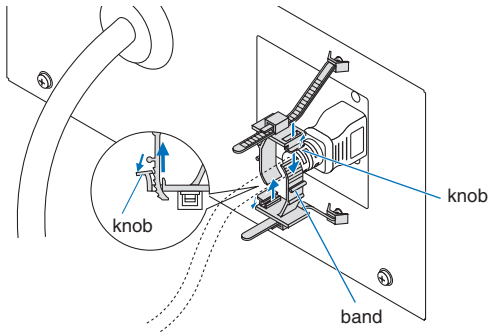

⚠ CAUTION

The projector may become hot temporarily when the power is turned off or if the AC power is disconnected while the projector is projecting. Take care when handling the projector.

2-3. Connecting the image input terminals

The video input ports that can be used with the IMB are as follows. Refer to the instruction manual of the IMB for details on connecting the video input ports with external equipment.

IMB	HDMI input port	x 1
	3G SDI input port	x 2

2-4. Connecting the various control terminal

For control, your projector comes with such ports as the PC control terminal and the Ethernet port (RJ-45).

- PC control terminal (RS-232) ----- Use this terminal when controlling the projector in serial connection from a PC.
- LAN port (LAN)----- Use this port when controlling the projector in LAN connection from a PC.

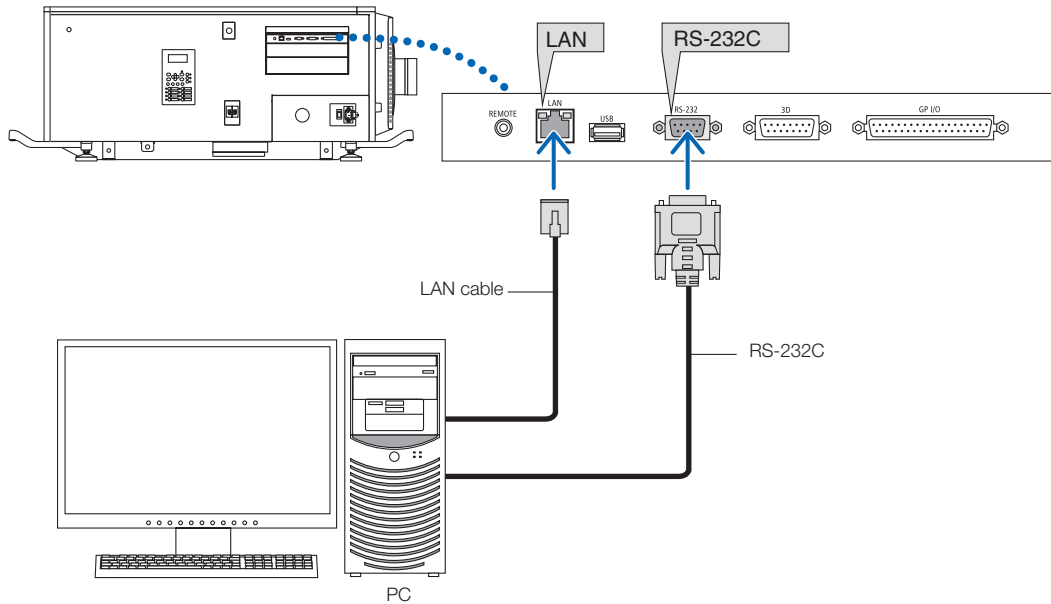

3.

Projection of Images (Basic Operation)

3-1. Steps of projecting images

- **Step 1**

Turn on the power to the projector. (See page [34](#))

- **Step 2**

Select the title of input signal. (See page [36](#))

- **Step 3**

Adjust the position and size of the projected screen. (See page [37](#))

- **Step 4**

Turn off the power to the projector. (See page [43](#))

3-2. Turning your projector on

WARNING

- The projector produces a strong light. When turning on the power, operate from the side or rear of the projector (outside the Restriction Zone (HD)). Also, when turning on the power, make sure no one within the projection range is looking at the lens.

- Preparation:**
- Connect the power cable to the projector (see page 27).
 - Supply AC power to the projector.

- NOTE**
- Turn off the main power switch to the projector when supplying or cutting AC power to the projector. Supplying or shutting down the AC power while the main power switch is on will damage the projector.
 - Turning on and off the projector involves a two-step operation; the “main power switch” and the “POWER button”.
 - Turning power on. (See this page)
 - [1] Turn on the “main power switch” of the projector.
Your projector is set in a standby state.
 - [2] If KEY LOCK is on, press the KEY LOCK button for one second or longer.
KEY LOCK is off and buttons on the control panel become operable.
 - [3] Press the POWER button three seconds or longer.
Your projector is turn on.
 - Turning power off. (See page 43)
 - [1] Press the POWER button three seconds or longer.
Your projector is set in a standby state.
 - [2] Turn off the “main power switch” of the projector.
Your projector is turned off.

1 Remove the lens cap.

2 Insert the administrator key horizontally into the administrator switch and turn it clockwise to the vertical position.

The administrator key can no longer be removed. The projector will not function unless the administrator key is inserted.

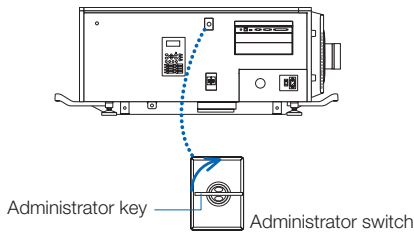

3 Turn on the power switches on the side of the projector in this order: first the light power switch **(1)** then the projector power switch **(2)**.

A buzzer will ring on the projector. The POWER button indicator will blink green and the SYSTEM status indicator will light orange (standby state). KEY LOCK becomes automatically on if no control panel operation takes place in the standby state for 30 seconds by default. Buttons on the control panel do not function while KEY LOCK is on. (See page 41)

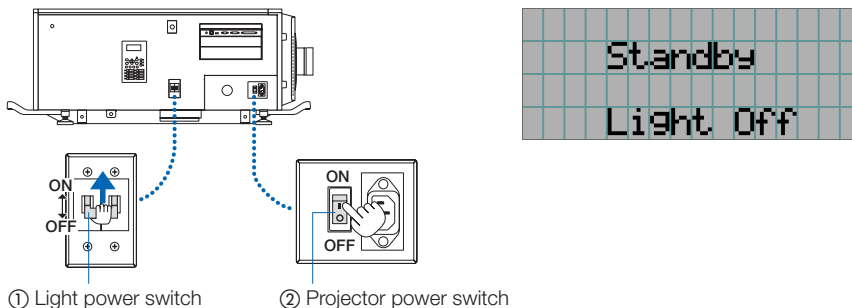

4 If KEY LOCK is on, press the KEY LOCK button for one second or longer.

KEY LOCK becomes off. The KEY LOCK button indicator turns off and buttons on the control panel become operable. (See page 41)

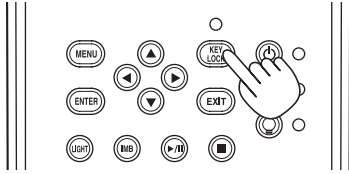

5 Press the POWER button on the control panel of your projector three seconds or longer.

Your projector is turn on.

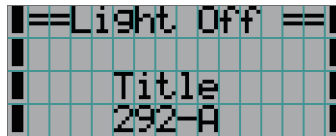
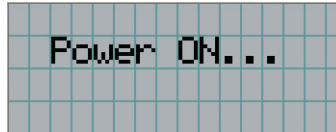
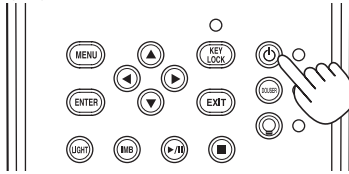

When the startup of the projector completes, the status of the POWER button, DOUSER button, LIGHT ON/OFF button, and preset button (button <1> to <8>) changes as follows.

POWER button	Lit green
DOUSER button	Initial settings: Off (douser is off)
LIGHT ON/OFF button	Initial settings: Blinking green (light source is off)
Button <1> to <8>	The preset button which was last selected is lit green

6 Press the LIGHT ON/OFF button on the control panel for three seconds or longer.

The light source is turned on and the screen glows light about 15 seconds later.

The LIGHT ON/OFF button indicator blinks in cycles of 2 (and changes to steady green light 90 seconds later).

The douser is closed until the screen glows light (the DOUSER button indicator lights green). When the douser is open, the DOUSER button indicator turns off.

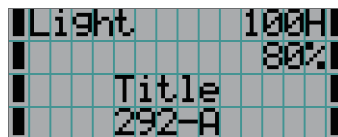
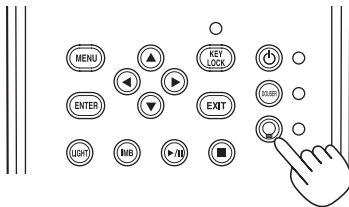

NOTE

- While your projector is on, be sure to have the lens cap and glass protector cap removed from the lens. Otherwise, the lens cap or glass protector cap may get deformed due to a heat buildup.
- In the following instances, the power to your projector cannot be turned on even if you press the POWER button.
 - When the inside temperature is abnormally high. The protective function prevents power from turning on. Wait some time (until the projector inside cools down) and then turn on the power.
 - When the SYSTEM status indicator is blinking in red without the light source lighting up after power-on. Your projector may be in trouble. Check the error display on the LCD screen and contact your dealer/distributor for instructions.

3-3. Selecting the title of input signal

This projector allows you to select pre-registered title (input signal) using the preset buttons on the control panel (up to 16 titles). Request your dealer/distributor for details on registering and changing titles. This section explains the steps for selecting registered titles.

- 1 Turn on the power to the image devices connected to the projector.
- 2 Press the MENU button.
- 3 Press the LEFT/RIGHT button to display “Title Select” on the LCD screen.

At each press of the LEFT/RIGHT buttons, the display will cycle as “Title Select” ↔ “Configuration” ↔ “(Title Setup)” ↔ “Information.”

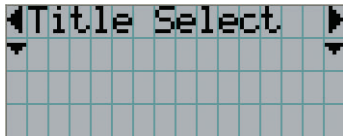

- 4 Press the DOWN button.

The title of the input signal is displayed.

- When you have made a wrong selection, press the UP button. A return will be made to the previous menu.



- 5 Press the LEFT/RIGHT buttons to display “Title of Signal to be Projected” on the LCD screen.

- 6 Press the ENTER button.

The title of the signal to be projected is selected.

- The (*) mark on the LCD indicates that this is the currently selected item.

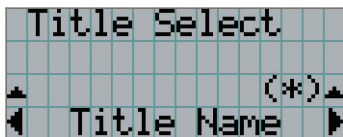

3-4. Adjusting the position and the size of projected screen

3-4-1. Displaying the test pattern

- 1 Press the MENU button, or select a test pattern from preset buttons (button <1> to <8>).

If you register the test patterns to the preset buttons (<1> to <8> buttons), select the test pattern according to "3-3. Selecting the title of input signal (See page 36)".

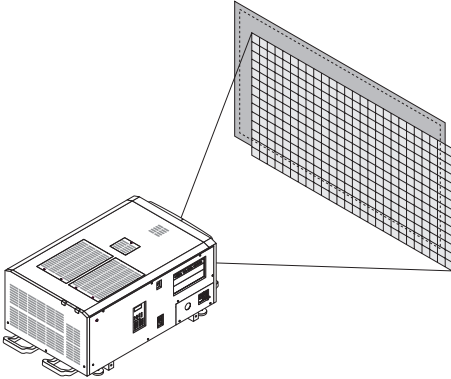

- 2 Press the LEFT/RIGHT button to display "Title Select" on the LCD screen.

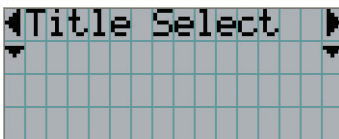

- 3 Press the DOWN button.

The title of the input signal is displayed.

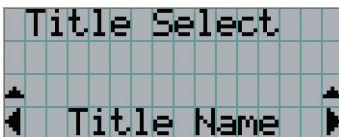

- 4 Press the LEFT/RIGHT button to display "TEST Pattern" on the LCD screen.

- 5 Press the DOWN button.

The LCD screen enters the mode where you can select a test pattern.



- 6 Press the LEFT/RIGHT button.

This switches the test pattern name displayed on the LCD screen.

3. Projection of Images (Basic Operation)

- 7 Display on the LCD the name of the test pattern to be projected, then press the ENTER button.

The test pattern is displayed.



To cancel the test pattern display, select the title of the signal to project or select the "OFF" test pattern.



3-4-2. Adjusting the position of the projected screen (Lens shift)

CAUTION

- Perform the adjustment from behind or from the side of the projector. If adjustments are performed from the front, your eyes could be exposed to strong light and get injured.

- 1 Press the MENU button.
- 2 Press the LEFT/RIGHT button to display "Configuration" on the LCD screen.
- 3 Press the DOWN button.
- 4 Press the LEFT/RIGHT button to display "Lens Control" on the LCD screen.
- 5 Press the DOWN button.

The screen ("Lens Position") to adjust the position of the projected screen is displayed.

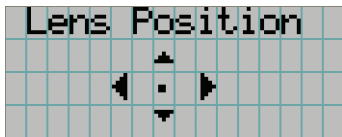

- 6 Press the UP/DOWN/LEFT/RIGHT button.

The position of the projected screen moves in the selected direction.

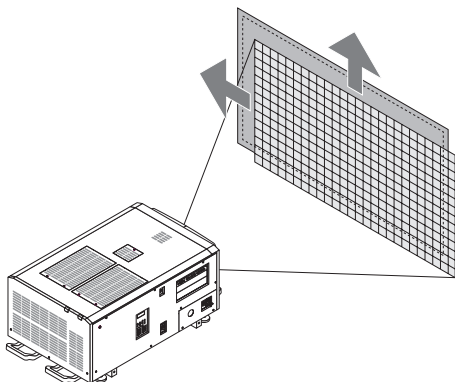

- 7 Press the EXIT button when adjustment is complete.

The display will return to a menu one level above (where "Lens Control" is displayed).

3-4-3. Adjustment of the size (zoom) and focus of the projected screen

- 1** Press the MENU button.
- 2** Press the LEFT/RIGHT button to display “Configuration” on the LCD screen.
- 3** Press the DOWN button.
- 4** Press the LEFT/RIGHT button to display “Lens Control” on the LCD screen.
- 5** Press the DOWN button.

The screen (“Lens Position”) to adjust the position of the projected screen is displayed.

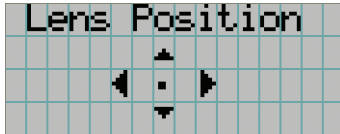

- 6** Press the ENTER button.

The screen to adjust the size and focus of the projected screen is displayed.

Press the ENTER button to switch the display between “Lens Position” and “Focus Zoom” adjustments.

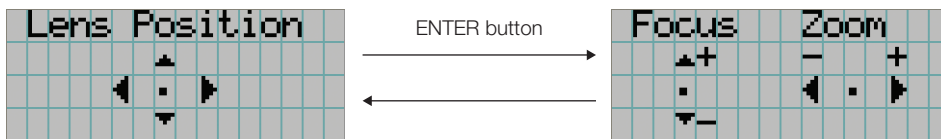

- 7** Adjust the size and focus of the projected screen.

Press the UP/DOWN button to adjust the focus.

Press the LEFT/RIGHT button to adjust the size.

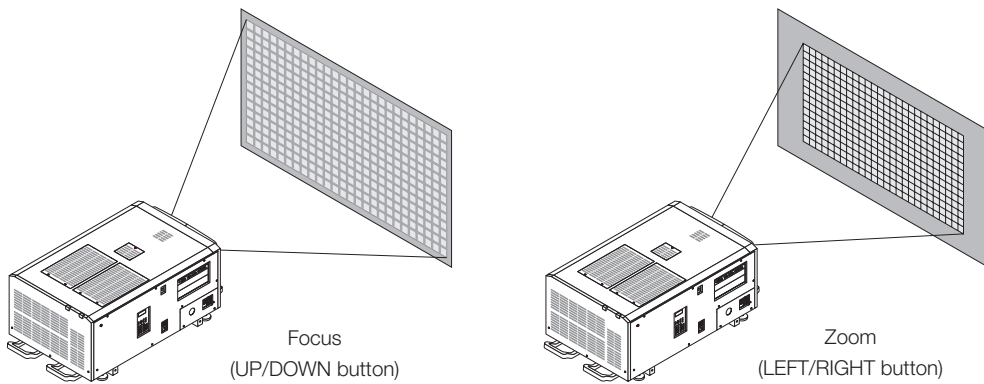

- 8** Press the EXIT button when adjustment is complete.

The display will return to a menu one level above (where “Lens Control” is displayed).

3. Projection of Images (Basic Operation)

3-4-4. Adjusting the brightness of the projected screen (Light output)

NOTE If the internal temperature within the projector rises due to the temperature in the room being high, the light output may be automatically reduced. This is called "Thermal Protection Mode (Down Light Power)". When the projector is in the Thermal Protection Mode, the picture brightness decreases slightly. To clear Thermal Protection Mode, adjust the light output. Consult with your dealer/distributor for details.

1 Press the LIGHT button.

The screen to adjust the light output is displayed.

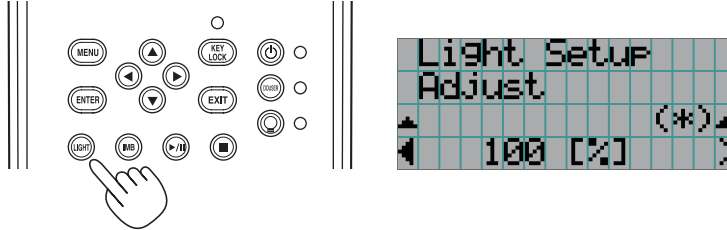

2 Press the LEFT/RIGHT button to adjust the light output.

The specified adjustment value is applied.

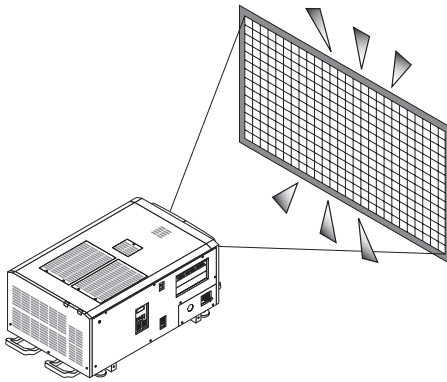

3-5. Preventing misoperations

Buttons on the control panel can be locked (KEY LOCK) to prevent misoperations. Buttons on the control panel do not function while KEY LOCK is on. KEY LOCK must be off to operate these buttons.

NOTE

- KEY LOCK is automatically turned on in the following cases.
 - When the projector has entered the standby state by turning on the main power switch of the projector while the AC power is supplied.
 - When the projector has entered the standby state after turning off the power using the POWER button.
- The timing where KEY LOCK is turned on while the projector is in standby state depends on the “Auto Key Lock” setting in the adjustment menu.
 - When Auto Key Lock is enabled, KEY LOCK becomes automatically on if no control panel operation takes place in the standby state for 30 seconds. KEY LOCK becomes automatically on again even after KEY LOCK is turned off if no control panel operation takes place for 30 seconds.
 - When Auto Key Lock is disabled, KEY LOCK becomes automatically on when the projector enters the standby state; however, it stays off after KEY LOCK is turned off.

3-5-1. KEY LOCK setting

- Press the KEY LOCK button on the control panel for one second or longer.

KEY LOCK becomes on. The KEY LOCK button indicator lights orange. When you press a button on the control panel of the projector while KEY LOCK is on, “Panel is Locked. (KEY LOCK)” is displayed, and the button will not function. (See page 46)

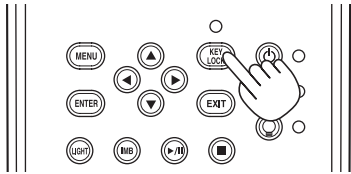

3-5-2. Turning KEY LOCK off

- Press the KEY LOCK button for one second or longer while KEY LOCK is on.

KEY LOCK becomes off. The KEY LOCK button indicator turns off.

3-6. Turning on/off the light with the projector turned on

3-6-1. Turning off the light

- Press the LIGHT ON/OFF button on the control panel for three seconds or longer.

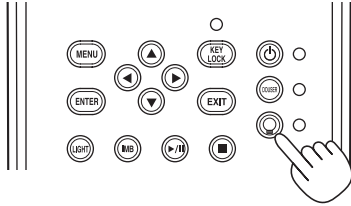

3-6-2. Turning on the light

- Press the LIGHT ON/OFF button on the control panel for three seconds or longer.

3. Projection of Images (Basic Operation)

4 Shut off the AC power supply to the main unit from the circuit breaker, etc.

NOTE In the following instances, do not turn off the main power switch or disconnect the AC power. Doing so can damage the projector.

- While projecting images
- While the fan is running after the power is turned off
 - While the projector is cooling down after the power was turned off.
 - When using the IMB: 90 seconds
 - During IMB operation (when the projector is not in the standby mode)

4. Using Menus

4-1. Basic operation with adjustment menus



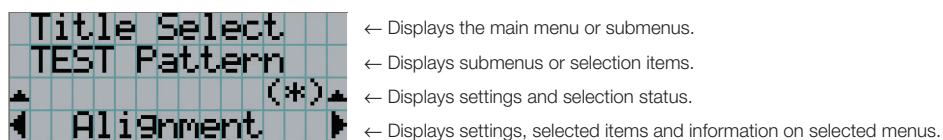

To adjust the projector, display the menu on the LCD screen of the projector control panel.

4-1-1. Screen display

The menu display screen is composed of a menu display field (the upper two lines) and a setting item display field (the bottom two lines).



The meanings of symbols in the menu display screen are outlined below.

	Indicates that there is a menu of a higher level. Press the UP button to return to a menu one level above.
	Indicates that there is a selected item or menu at the same level. Press the LEFT/RIGHT button to display other selected items or menus.
	Indicates that there is a menu of a lower level. Press the DOWN button to display the menu one level below.
	Indicates that there are setting items of a higher or lower level. Press the UP button to return to a menu one level above. Press the DOWN button to display the setting item one level below.

4. Using Menus

When not displaying menus, the following screen is normally displayed.

When in standby

When the projector is in a standby state (the main power switch in on), the following is displayed.

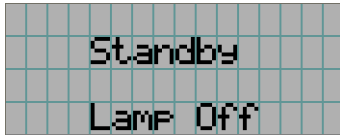

When power is turned on

When the power is turned on, the following is displayed.

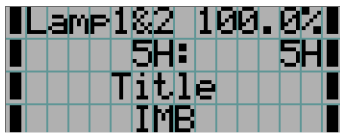

← Displays the light mode and light output (%).

← Displays the light usage time.

← Displays the selected title.

← Displays the selected video input port.

When the power is turned off

When you press the POWER button on the control panel of the projector for 3 or more seconds, the projector starts cooling. When cooling finishes, the projector enters the standby mode. The amount of time remaining for cooling is displayed as shown below during cooling.

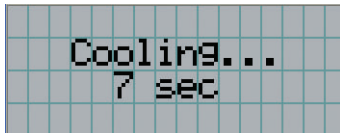

When a button is pressed while the key lock function is on

If a button on the control panel is pressed while the key lock function is on, the following is displayed and the button will not function.

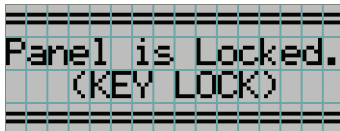

4-1-2. Operating menus

Preparation: Turn your projector on. (See page 34)

- 1 Press the MENU button on the control panel of your projector.

The menu is displayed in the LCD screen.



- 2 Press the LEFT/RIGHT buttons to display "Information."

At each press of the LEFT/RIGHT buttons, the display will cycle as "Title Select" ↔ "Configuration" ↔ "(Title Setup)" ↔ "Information."

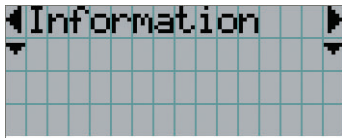

- 3 Press the DOWN button.

The submenu "Light" of "Information" is displayed.

The menu item can be selected by pressing the ENTER button instead of the DOWN button.

To return to the previous state, press the UP button, or the EXIT button.

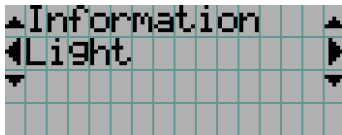

- 4 Press the LEFT/RIGHT button to select the submenu "Version."

At each press of the LEFT/RIGHT button, the display will cycle as "Light" ↔ "Lens Type" ↔ "Preset Button" ↔ "Usage" ↔ "Error Code" ↔ "Version" ↔ "IP Address" ↔ "Setup Date" ↔ "Option Status."

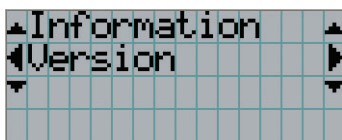

- 5 Press the DOWN button.

The submenu "System" another rank lower than "Version" is displayed.

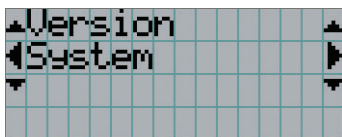

4. Using Menus

6 Press the DOWN button.

The submenu "BIOS" another rank lower than "Model" is displayed.

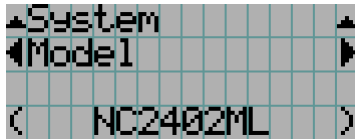

7 Press the LEFT/RIGHT button to select the submenu "Release Package."

At each press of the LEFT/RIGHT button, the display will cycle as "Model" ↔ "Serial No." ↔ "Release Package" ↔ "Kernel" ↔ "U-Boot" ↔ "System Files" ↔ "CinemaFirmware" ↔ "Cinema Data" ↔ "ICP Firmware" ↔ "ICP ConfigFile" ↔ "FMT FPGA" ↔ "Secure Processor" ↔ "Slave BIOS" ↔ "Slave Firmware" ↔ "Opt MCUFirmware" ↔ "LD Interface" ↔ "LD Driver1" ↔ "LD Driver2" ↔ "LD Driver3" ↔ "LD Driver4" ↔ "LD Driver5" ↔ "LD Driver6" ↔ "LD Driver7" ↔ "LD Driver8" ↔ "Lens Firmware" and each version information is displayed.

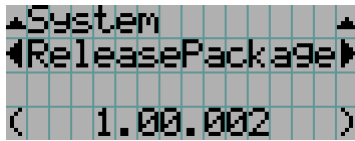

8 Press the UP button several times.

At each press of the UP button, the display will return to a menu one level above.

4-1-3. How to enter alphanumeric characters

Alphanumeric characters are entered for items, such as the log file of the specified period is written to USB memory. (See page 66)
 Characters can be entered by pressing numeric buttons on the control panel on this projector.

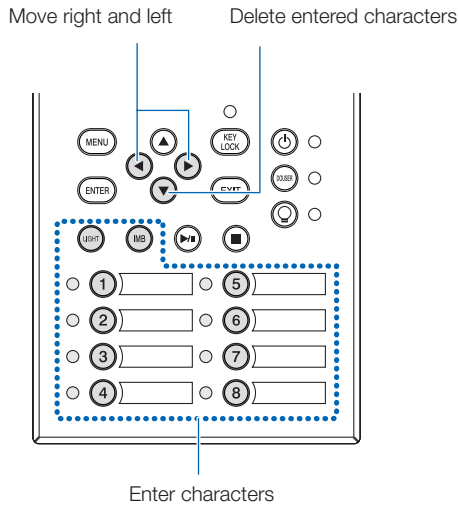

Characters can be entered by pressing each button as shown in the following table.

- To delete a character during entry, press the DOWN button.

[Example of Entry]

To enter "XGA" for example, use the following procedure:

- (1) Press the "8" button three times.
V → W → X
- (2) Press the RIGHT button.
XG
- (3) Press the "3" button.
XG
- (4) Press the RIGHT button.
XGA
- (5) Press the "1" button.
XGA

Button	Entered character
1	A → B → C → 1 → a → b → c → ! → ↑
2	D → E → F → 2 → d → e → f → " → ↑
3	G → H → I → 3 → g → h → i → # → ↑
4	J → K → L → 4 → j → k → l → \$ → ↑
5	M → N → O → 5 → m → n → o → % → ↑
6	P → Q → R → 6 → p → q → r → & → ↑
7	S → T → U → 7 → s → t → u → ' → ↑
8	V → W → X → 8 → v → w → x → (→ ↑
LIGHT	Y → Z → / → 9 → y → z → ? →) → ↑
IMB	* → , → . → 0 → ; → : → + → - → ↑

4-2. Table of adjustment menus

Menus in parentheses are menus for our service personnel. Normally, these menus cannot be used.

Main menu	Submenu		Description	Reference page	
Title Select	"Title Memory Name"		Selects the title of the signal to be projected.	52	
	TEST Pattern		Selects the test pattern to be projected.	52	
Configuration	Light Setup	Adjust	Adjusts light brightness.	53	
	Lens Control	Lens Position	Adjusts the position of the projected screen.	53	
		Focus Zoom	Adjusts the size and focus of the projected screen.	53	
	Reset	(Factory/Default)		Returns the settings to their default values. Selects between preset buttons and titles only, LAN settings only and all settings.	-
		Filter Cleaning		Initializes the air filter usage time (for confirming the filter cleaning time).	53
		(Fan Usage)		Initializes the usage time of the fan.	-
		(Light Usage)		Initializes the usage time of the light source.	-
		(Phosphor)		Initializes the usage time of the phosphor.	-
		(Diffuser)		Initializes the usage time of the diffuser.	-
		(Pump)		Reset the pump usage time.	56
		(Douser Count)		Resets the number of times the douser has been used.	-
	(Setup)	Douser Setup		Sets the douser open/close state.	-
		Panel Key Lock		Locks the buttons on the projector's control panel so that they cannot be operated.	-
		Auto Key Lock		Enables or disables Auto Key Lock.	-
		3D Reference		Sets the signal input terminal for a 3D image system (3D terminal or GPI/O terminal). Sets the video input port for 3D video systems.	-
		Off Timer		Sets the time until the projector power is turned off automatically.	-
		Message		Sets the time to display the message indicating the light replacement cycle, air filter replacement cycle, and air filter cleaning cycle.	-
		Silent Mode		Selects whether to use the status indicator, buzzer, indicators on the control panel and backlight.	-
		Installation (Note)	(Option Slot)		Configures the device installed in slot (only when the projector is in standby mode).
	(Orientation)		Sets the projection method and cooling fan operating mode.	-	
	Lens Type (Note)		This function cannot be used.	54	
	Lens Calibrate (Note)		Performs calibration on lens that support the lens memory function (only when the projector power is turned on).	54	
	Lens Center (Note)		Moves the lens shift position to the center (only when the projector power is turned on).	54	
	(Baudrate)		Sets the PC control connector (RS-232) data transmission speed (bps).	-	
	(Date/Time)		Sets the date and time on the projector.	-	
	(Fan Speed Mode)		Sets the cooling fan operating mode.	-	
	(Service)		(Only when the projector is in standby mode) This is used during shadow adjustment and lens mount adjustment (focus balance adjustment).	-	
	(LD Calibrate)		Performs calibration of the light module when the light module has been replaced (only when the projector power is turned on).	-	
	(Memory)	Light		The content of the selected light memory (light output power value) can be overwritten with the current settings.	-
		Lens		The content of the selected lens memory can be overwritten with the current settings.	-
(Title Setup)	Preset Button	Preset Button 1-16	Sets the title to be assigned to the preset buttons (<1> to <8> buttons).	55	

Main menu	Submenu		Description	Reference page
Information	Light	Light Output	Displays the light module's brightness (output) setting value.	55
		Model	Displays the light module's model name.	55
		S/N	Displays the serial number of the light module.	55
	Lens Type		This function cannot be used.	-
	Preset Button	Preset Button 1–16	Displays the titles which are assigned to the preset buttons (<1> to <8> buttons).	56
	Usage		Displays information related to projector usage.	56
	Error Code		Displays the currently occurring error.	56
	Version	System	Displays the model name and various version information about the projector.	57
		IMB	Displays the vendor name and version information about the media block (IMB).	57
	IP Address	System	Displays the IP address of the projector.	57
	Setup Date		Displays the date when the projector was set up (starting date of the warranty period).	58
	Option Status		Displays the link status of the device mounted in slot and projector.	58

(Note) Requires logging into the projector with Advanced User or higher privileges.

4-3. Title Select

4-3-1. Title select (Title Memory)

Selects the title of the signal to be projected.

You can register up to 100 titles. You can also assign registered titles to the preset buttons (<1> to <8> buttons) on the projector's control panel and call them up directly using those buttons.

Request your dealer/distributor for details on registering and changing titles.

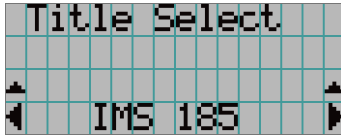

← Displays the currently selected item with asterisk (*).

← Selects the title to be projected.

4-3-2. Test Pattern

Selects the test pattern to be projected.



← Displays the currently selected item with asterisk (*).

← Selects the test pattern to be projected.

OFF, Alignment, Cross Hatch, Convergence, Red, Green, Blue, White, Black, White 50% [IRE], H-Ramp, Logo, MCG CG-TEST

4-4. Configuration

Please request your dealer/distributor to perform the settings.

4-4-1. Light Setup

Adjust

Adjusts the light output (brightness).

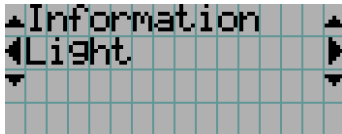

← Displays the current output power value (%) when the light rated output is 100%.

4-4-2. Lens Control

Adjust the position, size, and focus of the projected screen.

Press the ENTER button to switch the display between "Lens Position" and "Focus Zoom" adjustments. Press the EXIT button to return to a menu one level above.

Lens Position

Adjusts the position of the projected screen.

The projected screen moves in the selected direction as you press the UP/DOWN/LEFT/RIGHT button.

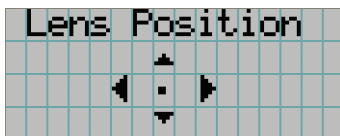

Focus Zoom

Adjusts the size (Zoom) and focus (Focus) of the projected screen.

Press the UP/DOWN button to adjust the focus.

Press the LEFT/RIGHT button to adjust the size of the projected screen.

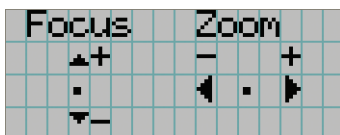

4-4-3. Reset

This is used to reset the light and air filter usage times.

Filter Cleaning

Resets the air filter usage time (for confirming the filter cleaning time).

[1] Press the ENTER button, the confirmation screen will appear.

[2] Select "Yes" in the confirmation screen, and then press the ENTER button to reset the filter usage time.

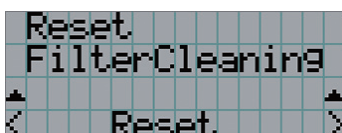

← Press the ENTER button to display the confirmation screen.

4. Using Menus

4-4-4. Installation

Lens Type

This function cannot be used.

Lens Calibrate

Performs calibration on lenses that support the lens memory function. Once you have attached a lens that supports the lens memory function, always execute calibration. This menu item is available only when the projector power is turned on and you are logged into the projector with Advanced User or higher privileges.

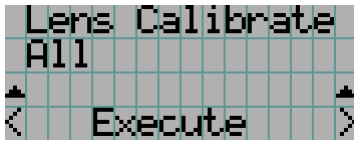

← Press the ENTER button to execute calibration.

All	Calibrates the zoom, focus and lens shift position.
Zoom&Focus	Calibrates the zoom and focus.
Shift(H&V)	Calibrates the lens shift position.

Lens Center

To move the lens shift to the center position. The center position may slightly shift depending upon mounting conditions of the lens. This menu item is available only when the projector power is turned on and you are logged into the projector with Advanced User or higher privileges.

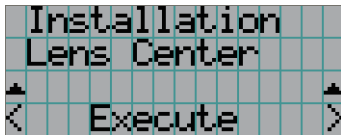

← Press the ENTER button to execute moving.

4-5. Title Setup

Sets the title to be assigned to the preset buttons (<1> to <8> buttons) (up to 16 titles).
Request your dealer/distributor to perform the settings.

4-6. Information

Displays the hours of light use, the version information and error codes.

4-6-1. Light

Displays the information of Light module.

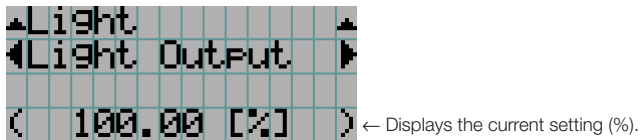

Light Output	Displays the light module's brightness (output) setting value.
Model	Displays the light module's model name.
S/N	Displays the serial number of the light module.

4-6-2. Lens Type

This function cannot be used.

4-6-3. Preset Button

Sets the title to be assigned to the preset buttons (<1> to <8> buttons) on the projector's control panel.

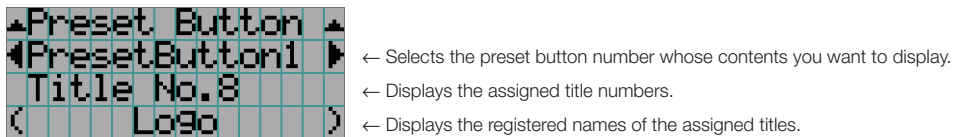

TIP To select a title allocated to one of "Preset Button9" to "Preset Button16", press the preset button while holding down the UP button. For example, to select the title allocated to "Preset Button9", press the <1> button while holding down the UP button.

4. Using Menus

4-6-4. Usage

Displays information related to the projector usage, such as the usage time of the projector, light, air filters, and fan, and information about the light replacement cycle.

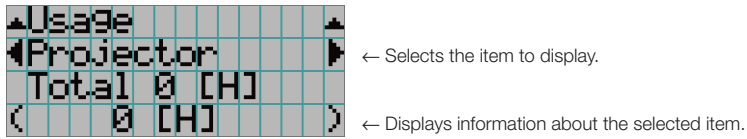

Projector	Displays the usage time of the projector. The upper row shows the usage time including standby mode while the lower row shows the usage time not including standby mode.
Filter Cleaning	Displays the air filter usage time.
Fan Usage	Displays the fan usage time.
Light Usage	Displays the usage time of the light source.
Phosphor	Displays the usage time of the phosphor.
Diffuser	Displays the diffuser usage time.
Pump	Displays the pump usage time.
Douser Count	Displays the number of times the douser has been used.

4-6-5. Error Code

Displays the error code when an error occurs.

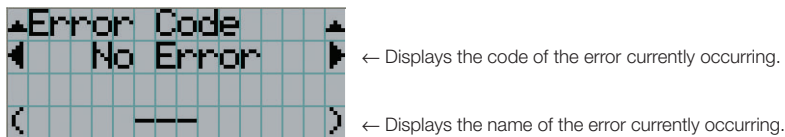

When multiple errors occur, you can display them by pressing the LEFT/RIGHT buttons.

4-6-6. Version

Displays version information about the projector, optional boards, and IMB.

System

Displays the version information of the projector.

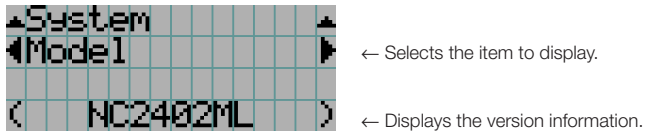

- Model
- Serial No.
- Release Package
- Kernel
- U-Boot
- System Files
- CinemaFirmware
- Cinema Data
- ICP Firmware
- ICP ConfigFile
- FMT FPGA
- Secure Processor
- Slave BIOS
- Slave Firmware
- Opt MCUFirmware
- LD Interface
- LD Driver1
- LD Driver2
- LD Driver3
- LD Driver4
- LD Driver5
- LD Driver6
- LD Driver7
- LD Driver8
- Lens Firmware

IMB

Displays the vendor name and version information about the media block (IMB). When the projector is in standby mode, the vendor name is blank and the version information displays "---".

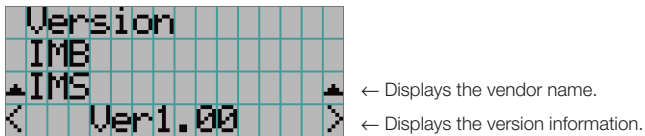

4-6-7. IP Address

Displays the IP address set in the projector.

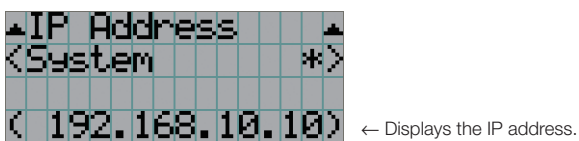

System	Displays the IP address set for the projector (System).
--------	---

4-6-8. Setup Date

Displays the date when the projector was set up (starting date of the warranty period).

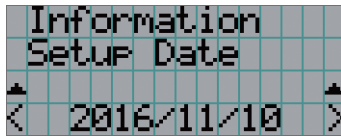

← Displays the date when the projector was set up (starting date of the warranty period).

4-6-9. Option Status

Displays the link status of the device mounted in slot on the projector. The device name is displayed in () when the projector is in standby or when connection to the device cannot be confirmed.

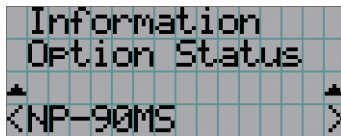

← Displays the link status of the device in slot.

- NP-90MS: NP-90MS02
- <Vendor Name> IMB: Media block
- No Board: No device mounted

5.

Maintenance of Your Projector

NOTE Please request your dealer to perform cleaning of the projector inside.

5-1. Cleaning the Cabinet

 **WARNING**

Pull out the power plug from the power outlet before cleaning the cabinet.

 **WARNING**

Please do not use a spray containing flammable gas to remove dust attached to the cabinet, etc. Doing so may result in fires.

- Wipe with a dry, soft cloth without nap.
When the cabinet is excessively dirty, wipe with cloth well wrung after being dampened with a neutral detergent diluted with water and then finish up with a dry cloth.
When you use a chemical dust cloth, follow the instructions in the manual attached to it.
- Do not use a solvent, such as thinner or benzene. The coating may deteriorate or peel off.
- When removing dust on the ventilation opening, suck it off using an adapter with a brush on a vacuum cleaner. Never allow the cleaner without an adapter to come into direct contact or use a nozzles adapter in cleaning.
- Clean the ventilation opening at regular intervals. Dust, if allowed to accumulate there, may cause heating inside, which leads to functional trouble. The interval, which can vary with the location of your projector, is about 100 hours.
- Do not damage the cabinet by scratching it or allowing hard objects to hit it. This can scratch the projector.
- Consult your dealer/distributor about cleaning the inside of the projector.

NOTE Do not allow insecticide or other volatile liquid to splash on the cabinet, lens or screen. Also, do not allow any rubber or plastic object to remain in contact with the cabinet for a long time. The coating may deteriorate or peel off.

5-2. Cleaning the Lens

Clean the lens the same way as with camera lens (using a commercially available camera blower or cleaning paper for glasses). Take care not to damage the lens when cleaning.

WARNING

Pull out the power plug from the power outlet before cleaning the lens.

WARNING

- Do not look into the light module while the projector is ON. Strong light is emitted from the projector and visual impairment could result.
- Please do not use a spray containing flammable gas to remove dust attached to the lens, etc. Doing so may result in fires.

5-3. Cleaning the Air Filters

Air filters are provided on the projector's air intakes to prevent dust from entering the projector. Clean the air filters regularly to maintain the performance of the projector.

- The usage time of the air filters can be checked at "Information" - "Usage" (page 55) on the adjustments menu.

WARNING

Pull out the power plug from the power outlet before cleaning the air filters.

WARNING

- If dust accumulates on the air filters, air intake to the projector will be insufficient and the internal temperature will rise, leading to fire or malfunction.
- Do not use a flammable gas spray to remove dust from the filters. Doing so may lead to fire.

CAUTION

- Before cleaning the air filters, turn off the power, wait for the cooling fan to come to a complete stop, turn off the projector power switch and the light power switch, interrupt the AC power supply, and make sure that the projector has cooled sufficiently. Removing the filter units during operation may cause burns or electric shock if the inside is touched.

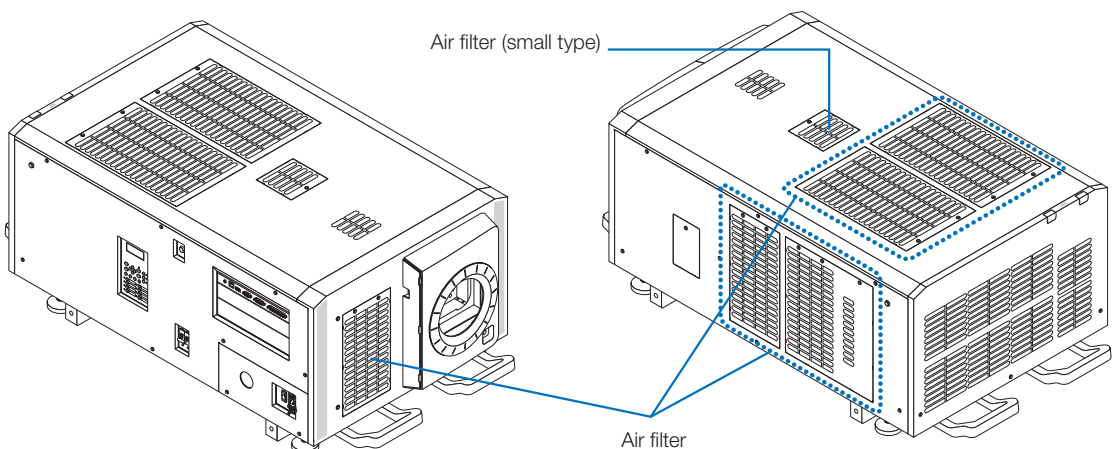

To remove the front air filter, pull the filter cover in the direction of the arrow. To install, insert the catches in the filter cover into the grooves in the lens cover, close the cover, then push it in.

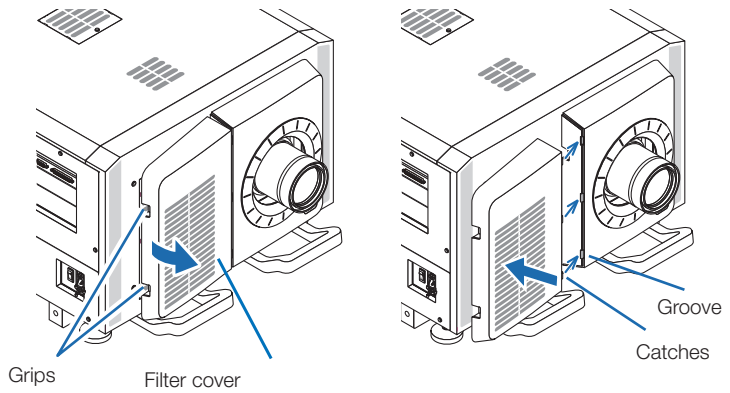

The illustration in this explanation shows how to clean the air filters on the top panel. Clean the other filters in the same way as these air filters (small type).

1 Remove the air filter.

Turn the 2 screws counterclockwise until they are disengaged, then lift the air filter a little to remove it.

- The screws do not come off.
- The number of screws differs depending on the air filter.

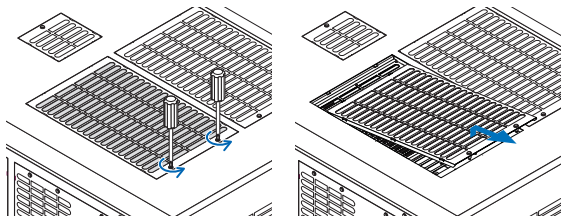

2 Remove the metal filter.

Note: The metal filter does not come off the small type air filters.

See “For small type air filters” on the next page.

(1) Turn the air filter upside down.

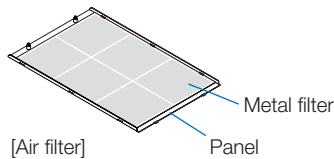

(2) Slowly bend the metal filter a little to unlatch the three catches from the grooves in the panel one by one.

Note: Bending the metal filter too much could damage it beyond repair. Be very careful to only bend the metal filters a little when removing them.

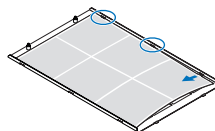

(3) Remove the metal filter from the panel.

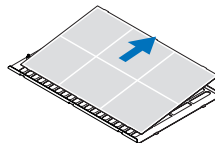

3 Use a vacuum cleaner to remove the dust.

Use a vacuum cleaner to remove the dust from both sides of the metal filter, the projector and the panel.

Note: Do not wash the metal filter in water. Doing so will cause the dust to clog the holes, reducing intake performance.

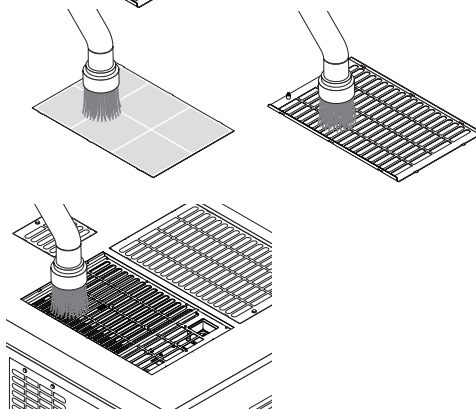

5. Maintenance of Your Projector

4 Attach the metal filter.

- (1) Insert the three catches on the metal filter into the grooves in the panel.
- (2) Bend the metal filter a little and insert the three projecting parts on the opposite side into the grooves in the panel, one by one.

Note: Bending the metal filter too strongly could damage it, rendering it unusable. Be very careful to only bend the metal filters a little when attaching them.

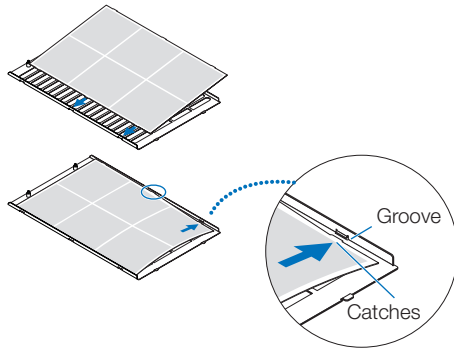

5 Attach the air filter to the projector.

- (1) Insert the catches in the air filter into the grooves in the projector.

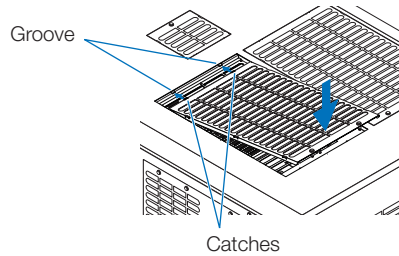

- (2) Turn the two screws clockwise to tighten them.
The number of screws differs depending on the air filter.

This completes cleaning of one of the air filters.
Clean the other air filters in the same way.

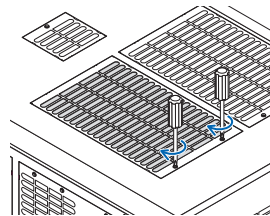

6 Reset the air filter usage time.

See "Filter Cleaning" under "Reset" on Page 53.

For small type air filters

1. Using the procedure in step 1, turn one screw counterclockwise until it is disengaged, then lift the air filter (small type) a little to remove it.

The screws do not come off.

2. Use a vacuum cleaner to remove the dust.

Use a vacuum cleaner to remove the dust from both the front and back sides of the filter and from the projector.

Note:

- Do not remove the metal filter. Doing so may bend it, rendering it unusable.
- Do not wash the air filter in water. Doing so will cause the dust to clog the holes, reducing intake performance.

3. Using the procedure in step 5, turn one screw clockwise to tighten it.

4. Perform the operation in step 6.

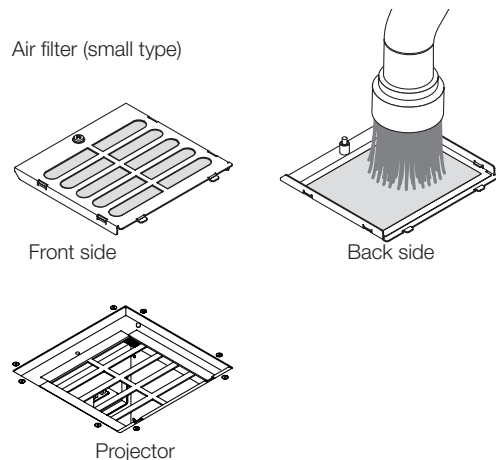

6.

Appendix

6-1. Troubleshooting

Before asking for repair, please check your connection, settings and operation once again. If the trouble cannot be corrected, please contact your dealer/distributor for instructions or repair.

6-1-1. Problems and where to check

Problem	Check these items
The projector cannot be turned on.	Check to see if AC power is supplied to the projector.
	Are the projector power switch and the light power switch turned on?
	Check to see whether the panel key lock function is activated. If so, the main unit's control buttons are locked and do not work.
	Is the temperature inside the projector too high? When the inside temperature is too high, the protective function does not allow your projector to be turned on. Wait some time and then turn it on.
	Is the administrator key inserted? The projector will not function unless the administrator key is inserted.
The image cannot be projected.	Check to see if the connected input has been selected.
	Check to see if a cable is properly connected to the input terminal.
	Check to see whether the douser is closed.
	Check to see if the settings are all adjusted properly.
The image is distorted.	Check to see if the protractor is properly set up.
The image is blurred.	Make certain that the lens is properly focused.
	Check to see if the screen and a projector are installed at correct angles.
	The projection distance may be larger than the focusing range. See if the lens and other parts have condensation on them. If the projector is turned on in a warm place after storage in a cold place, the lens and other optical components inside may develop condensation. In such a case, please wait several minutes until the condensation disappears.
Video image is disturbed.	Check whether the signal cable connected to the projector is disconnected.
The STATUS indicator blinks in red.	Your projector may have trouble. Please contact your dealer/distributor for instructions.
An error code is displayed.	Please contact your dealer/distributor for instructions.

6-2. Indicator display list

See the descriptions below when the buttons on the control panel or the STATUS indicator on the rear of the projector is lit or blinking. The projector also has a warning function that uses a buzzer.

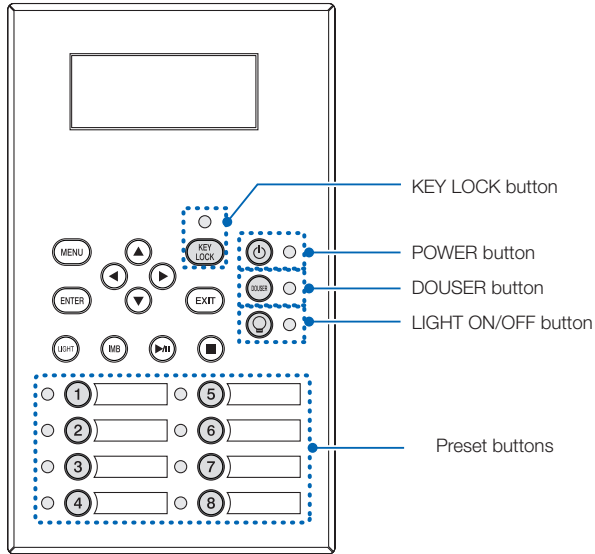

6-2-1. Preset buttons

Indicator condition		Projector condition	Note
Off		No title is assigned to the button.	-
Steady light		A title is assigned to the button.	-
	Green	The title is being selected.	-
	White	The title is not selected.	-

6-2-2. KEY LOCK button

Indicator condition		Projector condition	Note
Off		The key lock is off.	-
Steady light	Orange	The key lock is on.	-

6-2-3. POWER button

Indicator condition		Projector condition	Note
Off		The projector power supply is off.	-
Blinking light	Orange	While the projector software is starting	Wait for a moment.
	Green (cycles of 1) (Note 1)	Preparing to turn power on/cooling fan rotating (State from turning the power off to entering standby mode).	Wait for a moment.
	Green (cycle of 3 seconds) (Note 2)	When the sleep timer is activated	-
Steady light	Green	The projector is turned on.	-
	Orange	The projector is in standby.	-

(Note 1) Repeats 0.5 seconds on → 0.5 seconds off.

(Note 2) Repeats 2.5 seconds on → 0.5 seconds off.

6-2-4. DOUSER button

Indicator condition		Projector condition	Note
Steady light	Green	The douser is closed.	-
Off		The douser is opened.	-

6-2-5. LIGHT ON/OFF button

Indicator condition		Projector condition	Note
Off		The light is off.	-
Steady light	Green	The light is on.	-

6-2-6. STATUS indicator

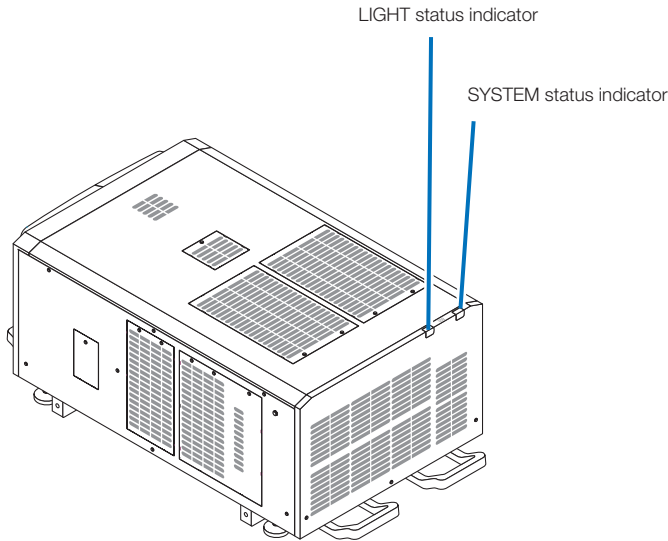

SYSTEM status indicator

Indicator condition		Projector condition	Note
Off		Main power is off.	-
Blinking light	Green	The projector is getting ready to turn on. The douser is closed. The light is off.	Wait for a moment.
	Orange	The projector is cooling down.	Wait for a moment.
	Red (With buzzer)	Safety problem, error.	An error message is displayed in the LCD screen. Check the content of the error.
	Red (Without buzzer)	Error with possible image project under certain conditions.	
Steady light	Green	The projector is turned on.	-
	Orange	The projector is in standby.	-
	Red	Error at a level with not affect on projection.	An error message is displayed in the LCD screen. Check the content of the error.

LIGHT status indicator

Indicator condition		Projector condition	Note
Off		The light source is off.	-
Steady light		The light source is on.	-

6-3. Operation using an HTTP browser

6-3-1. Overview

The use of HTTP server functions will allow control of the projector from a web browser. Please be sure to use “Microsoft Internet Explorer 4.x” or a higher version for the web browser.

This device uses “JavaScript” and “Cookies” and the browser should be set to accept these functions. The setting method will vary depending on the version of the browser. Please refer to the help files and the other information provided in your software.

NOTE The display's or button's response can be slowed down or operation may not be accepted depending on the settings of your network.
Should this happen, consult your network administrator.
The projector may not respond if its buttons are repeatedly pressed in rapid intervals. Should this happen, wait a moment and repeat.
Access is gained to the HTTP server functions by and specifying
`http://<the projector's IP address>/index.html`
in the entry column of the URL.

6-3-2. Preparation before use

Make network connections and set up the projector and confirm that it is complete before engaging in browser operations.

Operations with a browser that uses a proxy server may not be possible depending on the type of proxy server and the setting method. Although the type of proxy server will be a factor, it is possible that items that have actually been set will not be displayed depending on the effectiveness of the cache, and the contents set from a browser not be reflected in operation. It is recommended that a proxy server not be used unless it is unavoidable.

6-3-3. URL for connecting to the HTTP server

Normally, the URL of the HTTP server is “`http://<this projector's IP address>/index.html`”, but if the conditions below are met, connection is possible with the URL using the projector's host name.

- the projector's host name is registered on the domain name server
- the projector's IP address and host name have been added to the “HOSTS” file on the computer

(Example 1) When the projector's host name is set to “pj.nec.co.jp”

To access the HTTP server function, enter

“`http://pj.nec.co.jp/index.html`” in the address or URL input field.

(Example 2) When the projector's IP address is “192.168.10.10”

To access the HTTP server function, enter

“`http://192.168.10.10/index.html`” in the address or URL input field.

6-3-4. Structure of the HTTP server

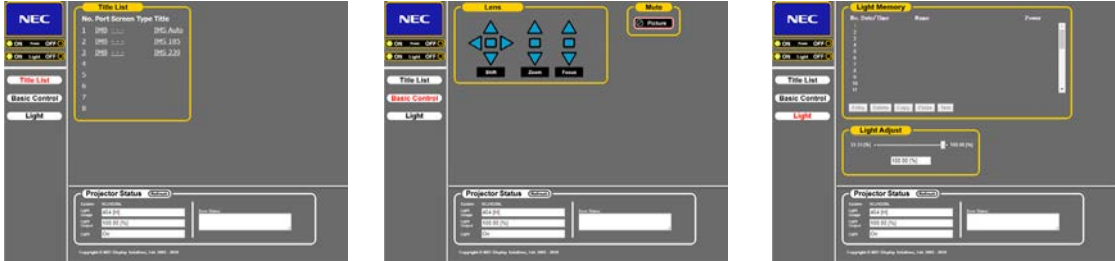

Power		Controls the power to your projector. <ul style="list-style-type: none"> On: Turns the power on. Off: Turns the power off.
Light		Turn the light on/off. <ul style="list-style-type: none"> On: Turns the light on. Off: Turns the light off.
Title List		Displays titles set in the projector (such as input port, screen type, and title). Check, and the title will be changed.
Basic Control		Displays the basic control items.
Lens	Shift	Controls the lens operation. <ul style="list-style-type: none"> ▲ : Shifts the projected screen upward. ▼ : Shifts the projected screen downward. ◀ : Shifts the projected screen leftward. ▶ : Shifts the projected screen rightward. ■ : Stops the shifting. Shifting can also be stopped by clicking the same button one more time.
	Zoom	<ul style="list-style-type: none"> ▲ : Zooms up the lens. ▼ : Zooms down the lens. ■ : Stops the zooming. Zooming the can also be stopped by clicking the same button one more time.
	Focus	<ul style="list-style-type: none"> ▲ : Focuses up the lens. ▼ : Focuses down the lens. ■ : Stops the focusing. Focusing can also be stopped by clicking the same button one more time.
Mute	Picture	Click and the douser closes and the projected picture disappears. Click once again and the picture will be projected again.
Projector Status		Displays the condition of the projector. <ul style="list-style-type: none"> Light Usage: Displays the hours of light use. Light Power: Displays light output (%). Light Status: Displays the status of the light (On: Lights / Off: Off). Error Status: Displays the status of errors occurring within the projector. Refresh: Updates the display of the following conditions.
Light Memory	Entry	Saves the current light output value in the memory.
	Delete	Deletes the memory selected in the list from the Light Memory.
	Copy	Copies the memory selected in the list.
	Paste	Saves/overwrites the copied memory to the selected memory in the list.
	Test	Tests the adjustment value of the memory selected in the list.

6-4. Writing of the log file (Save Information)

Log files saved on the main unit can be written to USB memory connected to the USB port of the main unit. To perform the writing of the log file, use the following procedure.

1 Connect the USB memory to the USB port of the main unit.

Wait until the USB memory is recognized, and it enters the condition in which it can be used (5 or more seconds). For details, refer to the instruction guide of the USB memory.

2 Simultaneously press the UP button and ENTER button.

The "Save Info." screen is displayed.

```

** Save Info. **
  Date Filter
  ◀ Today ▶
*****

```

TIP If you press the EXIT button during operation, operation is stopped and the display returns to the normal screen.

3 Press the LEFT/RIGHT button, and select the log file writing period.

The items that can be selected are as follows.

Today	Writes today's log files.
7days	Writes 7 days' log files from today.
30days	Writes 30 days' log files from today.
2years	Writes 2 years' log files from today.
Manual	Writes the specified period's log files.

4 Press the ENTER button.

When "Today", "7days", "30days" or "2years" is selected, the log file writing period is displayed.

```

** Save Info. **
2016/03/11 Fri
2016/03/18 Fri
◀ Execute ▶

```

← The log file writing period is displayed.

6. Appendix

When "Manual" is selected, specify the log file writing period. For how to enter numerals, refer to "4-1-3. How to enter alphanumeric characters" (See page 49). If you press the ENTER button, the display advances to the following screen.

```
** Save Info. **
Date Filter
From Date
[2016/03/18 Fri] ← Enter the date/time to start writing.
```

↓
Press the ENTER button.

```
** Save Info. **
Date Filter
To Date
[2016/12/21 Wed] ← Enter the date/time to stop writing.
```

↓
Press the ENTER button.

```
** Save Info. **
2016/03/18 Fri
2016/12/21 Wed
◀ Execute ▶ ← The log file writing period is displayed.
```

- 5 Confirm the log file writing period, press the LEFT/RIGHT button to select "Execute," and press the ENTER button.

The log files of the specified period are written to the USB device. When writing completes, the following screen is displayed.

```
** Save Info. **
Complete(USB)
<OK>
*****
```

.....
TIP If you select "Cancel" and press the ENTER button, the writing of log files is stopped, and the display returns to the normal screen.
.....

- 6 Press the ENTER button.

The display returns to the normal screen.

```
Light 100H
80%
Title
292-A
```

- 7 Remove USB memory from the USB port of the main unit.

6-4-1. Names of log files

Written log files are saved with the following file names.

(Model name)_(Serial Number)_YYMMDDHHmm.txt

(Model name)	This shows the model of projector.
(Serial Number)	This shows the serial number of projector.
YYMMDDHHmm	Shows the date/time when written. YY: Year (lower 2 digits) MM: Month (2 digits) DD: Date (2 digits) HH: Hour (2 digits) mm: Minute (2 digits)

For example, when the NC2402ML log file is written at 14:05 on January 28, 2019 (2019/01/28), it will be saved with the filename "NC2402ML_abcd1234_1901281405.txt".

6-5. Outline Drawing

6-5-1. Projector

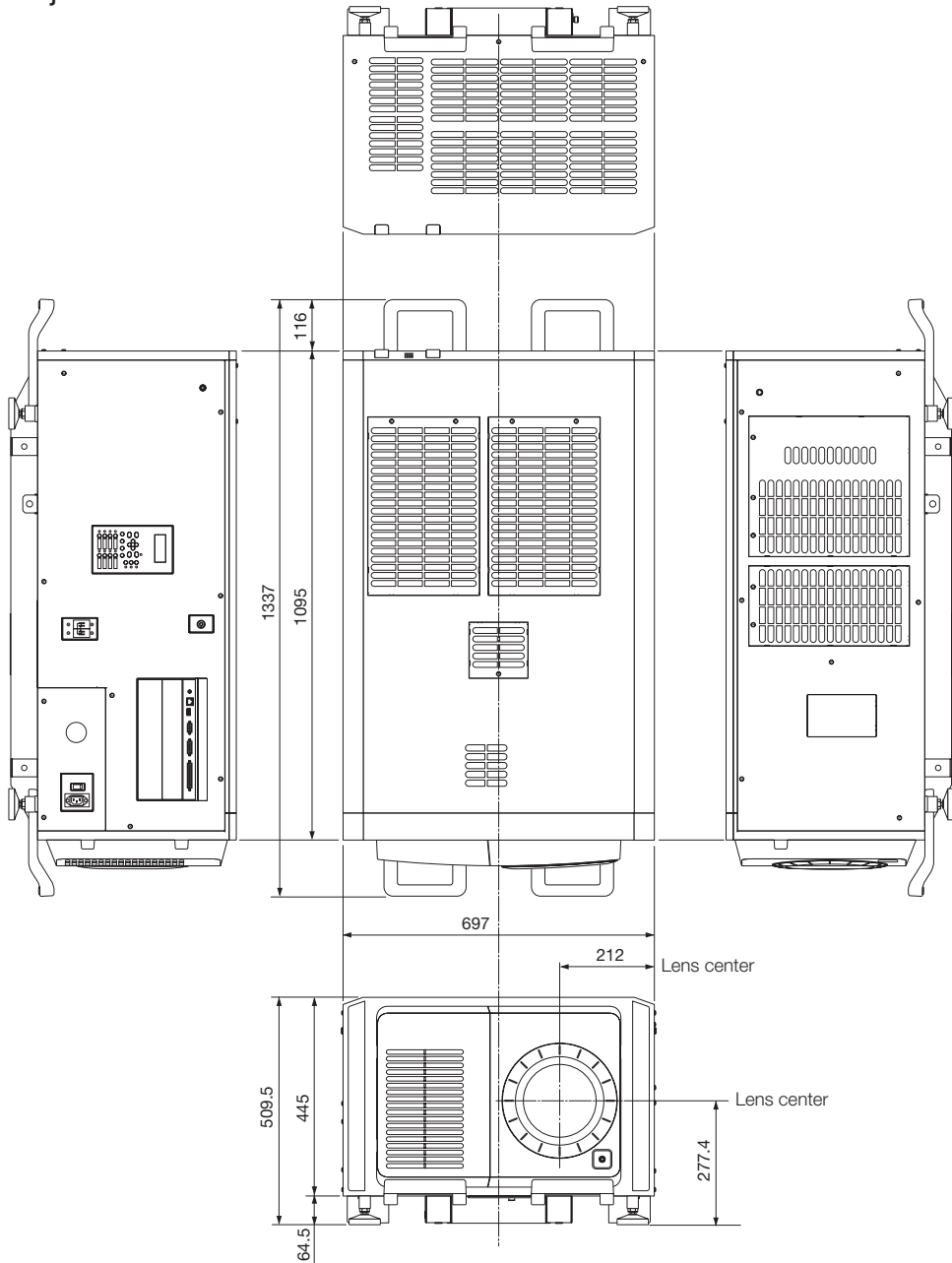

Units: mm

6-6. Specifications

6-6-1. Projector

Model name		DLP Cinema® Projector Head : NP-02HD		
Light Module		NP-24LU01	NP-20LU01	NP-18LU01
		NP-24LU03	NP-20LU03	NP-18LU03
DLP Cinema® Projector		NP-NC2402ML	NP-NC2002ML	NP-NC1802ML
		NP-NC2403ML	NP-NC2003ML	NP-NC1803ML
Projection method		3 chip DLP Cinema® method		
		0.98-inch DC2K chip		
Panel resolution		2048 × 1080		
Light type		Laser Diode		
Screen sizes		Max. 22 m	Max. 20 m	Max. 19 m
		@14ft-L / Screen Gain 1.8 (Depends on setup conditions)		
Contrast ratio		2000:1 with DCI specified color representation		
Lens adjustment function		Motorized lens shift (vertical/horizontal), motorized zoom, motorized focus, douser		
Signal input ports		When shipped from factory: Empty (for mounting optional components) (Note 1)		
External Control		RS-232C (D-sub 9pin) x 1 GPIO port (D-sub 37 pin) x 1 Service terminal (stereo mini jack) x 1 3D CTL (D-sub 15 pin) x 1	USB (Type A) x 1 Interlock port x 1 Ethernet port (G-bit RJ-45) x 1	
Power supply voltage				
With C1 connection (Note 3)	Projector power supply + Light power supply	Single-phase AC 200V-240V 50/60 Hz		
	Projector power supply	Single-phase AC 100V-240V 50/60 Hz		
With C2 connection (Note 3)	Projector power supply	Single-phase AC 200V-240V 50/60 Hz		
	Light power supply	Single-phase AC 200V-240V 50/60 Hz		
Input current				
With C1 connection (Note 3)	Projector power supply + Light power supply	18.1 A		
	Projector power supply	for AC 100 V	6.0 A	
for AC 200 V		2.9 A		
	Light power supply	15.2 A		
Power consumption				
With C1 connection (Note 3)	Projector power supply + Light power supply	NP-24LU01 NP-NC2402ML	NP-20LU01 NP-NC2002ML	NP-18LU01 NP-NC1802ML
		3,070 W	2,792 W	2,988 W
With C2 connection (Note 3)	Projector power supply	368 W	336 W	305 W
		Light power supply	2,702 W	2,456 W
With C1 connection (Note 3)	Projector power supply + Light power supply	NP-24LU03 NP-NC2403ML	NP-20LU03 NP-NC2003ML	NP-18LU03 NP-NC1803ML
		2,699 W		2,934 W
With C2 connection (Note 3)	Projector power supply	322 W		312 W
		Light power supply	2,377 W	2,622 W
Cooling method		Air cooling system and liquid cooling system		
Noise level		50 dB or less		
Installation		Orientation: Desk/ front, desk/ rear, ceiling/ front, ceiling/ rear		
Net weight		150 kg (total weight of projector and NP-24LU01/NP-24LU03 or NP-20LU01/NP-20LU03 light module. Not including the lens.)	141 kg (total weight of projector and NP-18LU01/NP-18LU03 light module. Not including the lens.)	
Dimensions		697 mm (width) × 1,095 mm (depth) × 509.5 mm (height)		
Environment		Operating temperature: 10 to 35°C Operating humidity: 10 to 85% (non-condensing) Storage temperature: -10 to 50°C Storage humidity: 10 to 85% (non-condensing) Operating altitude: 0 to 3000 m/9800 feet		

(Note 1) The video input slots are empty when the device is shipped. Input ports can be added by mounting option boards, which are sold separately. (See page 79)

(Note 2) The value is typical.

(Note 3) A "C1 connection" is when the AC power is supplied to the projector power supply and the light power supply with a single power cable.

A "C2 connection" is when the AC power is supplied to the projector power supply and the light power supply by separate power cables.

* For the standards related to laser products to which this projector conforms, see the section "To ensure safe use of this unit, be sure to read this before using the unit" (page 2).

* Note that these specifications and design can change without prior notice.

6-7. Pin Assignment and Functions of Terminal

6-7-1. PC CONTROL connector (RS-232) (D-sub 9 pin)

This is an RS-232C interface for controlling the projector from a PC. The projector operates as a DCE (Data Communication Equipment), so use a straight cable when connecting to a PC.

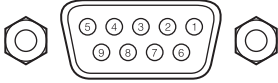

Pin No.	RS-232C Signal Name	Functions as RS-232C	Projector Connector Operation
1	CD	Carrier detection	Not used (N.C.)
2	RXD	Reception data	Data transmission to an external device
3	TXD	Transmission data	Data reception from an external device
4	DTR	Data Terminal ready (Note)	Connection to 6 pins
5	GND	Signal GND	Signal GND
6	DSR	Data set ready (Note)	Connection to 4 pins
7	RTS	Transmission request	SYSTEM: Hi-Z (Not used) CINEMA: Hi-Z (Used)
8	CTS	Transmission available	SYSTEM: Fixed at -6.5 V (Not used) CINEMA: ± 10.5 V (Used: Depends on communication status)
9	RI	Ring indicator	Not used (N.C.)

(Note) Do not use DTR and DSR signals when communicating.

6-7-2. External control connector (GP I/O) (D-sub 37 pin)

It is possible to control the projector with an external device and to control the external device from the projector using an external control connector (GPIO: General Purpose I/O Ports). Each pin is electrically separated from the projector internal circuits by a photo-coupler. 8 port input and 8 port output are available.

Please contact your dealer/distributor regarding how to use and to operate them.

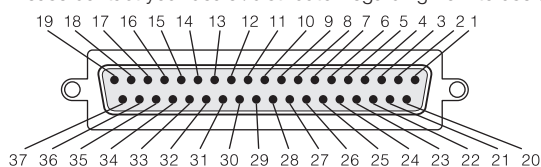

Pin view of female connector

Pin No.	Signal Name	I/O	Pin No.	Signal Name	I/O
1	GPIN1+ (3D L/R Input Reference +)	IN	20	GPIN1- (3D L/R Input Reference -)	IN
2	GPIN2+ (3D L/R Display Reference +)	IN	21	GPIN2- (3D L/R Display Reference -)	IN
3	GPIN3+ (system reserved)	IN	22	GPIN3- (system reserved)	IN
4	GPIN4+ (system reserved)	IN	23	GPIN4- (system reserved)	IN
5	EXT_GPIN1+ (Control and Title Selection +)	IN	24	EXT_GPIN1- (Control and Title Selection -)	IN
6	EXT_GPIN2+ (Control and Title Selection +)	IN	25	EXT_GPIN2- (Control and Title Selection -)	IN
7	EXT_GPIN3+ (Control and Title Selection +)	IN	26	EXT_GPIN3- (Control and Title Selection -)	IN
8	EXT_GPIN4+ (Control and Title Selection +)	IN	27	EXT_GPIN4- (Control and Title Selection -)	IN
9	GPOUT1+ (External 3D L/R Output Reference +)	OUT	28	GPOUT1- (External 3D L/R Output Reference -)	OUT
10	GPOUT2+ (system reserved)	OUT	29	GPOUT2- (system reserved)	OUT
11	GPOUT3+ (system reserved)	OUT	30	GPOUT3- (system reserved)	OUT
12	GPOUT4+ (Internal 3D L/R Output Reference +)	OUT	31	GPOUT4- (Internal 3D L/R Output Reference -)	OUT
13	EXT_GPOUT1+ (Projector Ready/Busy +)	OUT	32	EXT_GPOUT1- (Projector Ready/Busy -)	OUT
14	EXT_GPOUT2+ (Projector Error Status +)	OUT	33	EXT_GPOUT2- (Projector Error Status -)	OUT
15	EXT_GPOUT3+ (IMB Play/End Status +)	OUT	34	EXT_GPOUT3- (IMB Play/End Status -)	OUT
16	EXT_GPOUT4+ (Projector Heartbeat +)	OUT	35	EXT_GPOUT4- (Projector Heartbeat -)	OUT
17	NC (not connected)	-	36	NC (not connected)	-
18	GND	PWR	37	GND	PWR
19	GND	PWR	-	-	-

EXT_GPIN1 - EXT_GPIN4: You can control the projector externally by combinations of input signals (high/low). (Projector power supply/turning the light source on or off/image mute/title selection)

EXT_GPOUT1 - EXT_GPOUT4: Functions in the above table are default settings. You can change the assigned functions.

Input Connector

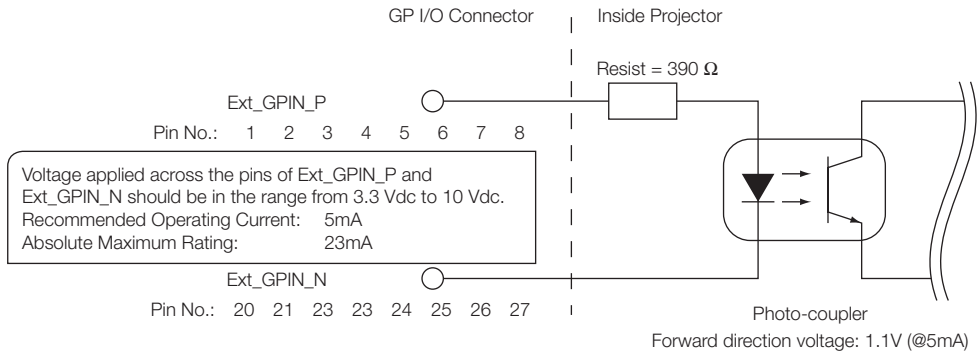

• **Using GPIO Control**

Momentary “ON” pulse enables you to control projector. To enable “ON” pulse, hold it for at least 500 ms. Hold “OFF” for at least 500 ms before “ON”. (See page 77)

Here is function list to control projector by using GPIO port.

Pin No.	Photo-coupler ON/OFF				Function
1-20	ON/OFF				3D L/R timing signal input ON/OFF
2-21	ON/OFF				3D L/R display timing signal input ON/OFF
3-22	-				System reserved (used internally)
4-23	-				System reserved (used internally)
5-24 6-25 7-26 8-27	8-27	7-26	6-25	5-24	The following functions apply depending on the combination of input terminals.
	OFF	OFF	OFF	ON	Power ON
	OFF	OFF	ON	OFF	Power OFF
	OFF	OFF	ON	ON	Light source ON
	OFF	ON	OFF	OFF	Light source OFF
	OFF	ON	OFF	ON	Image douser ON
	OFF	ON	ON	OFF	Image douser OFF
	OFF	ON	ON	ON	System reserved (used internally)
	ON	OFF	OFF	OFF	Selects the title registered to the preset button 1
	ON	OFF	OFF	ON	Selects the title registered to the preset button 2
	ON	OFF	ON	OFF	Selects the title registered to the preset button 3
	ON	OFF	ON	ON	Selects the title registered to the preset button 4
	ON	ON	OFF	OFF	Selects the title registered to the preset button 5
	ON	ON	OFF	ON	Selects the title registered to the preset button 6
	ON	ON	ON	OFF	Selects the title registered to the preset button 7
	ON	ON	ON	ON	Selects the title registered to the preset button 8

Example for dousing image: Input ON to 5-24 and 7-26 while 6-25 and 8-27 are OFF.

Example for selecting the preset button 2: Input ON to 5-24 and 8-27 while 6-25 and 7-26 are OFF.

NOTE

- The operation command coming from GPI/O port will be canceled when the projector is processing other tasks, such as light source cooling and switching title.
- Set all other pins than those in use to “OFF”.
- The operation command is executed upon continuous input of the “ON” pulse for approximately 200 ms.

• Timing chart of GPIO control

Example of Select Preset Button

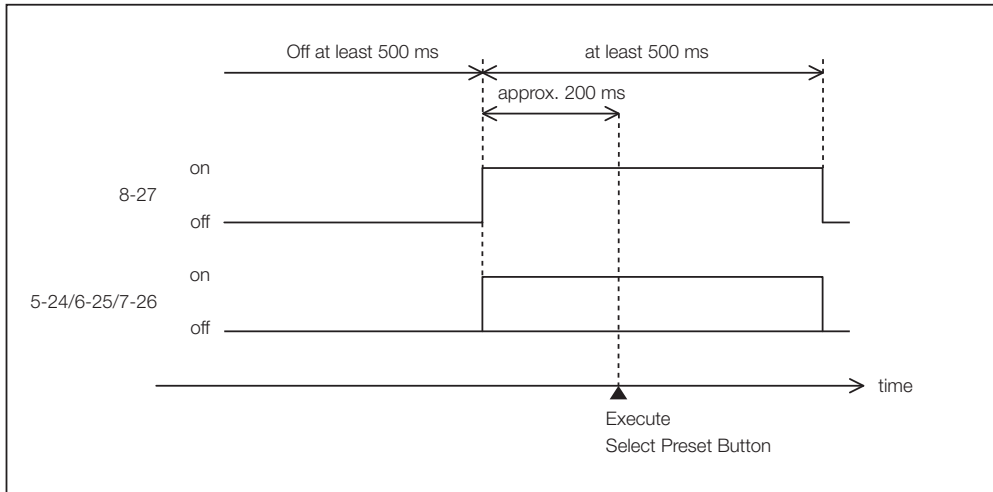

Example for turning the image douser (Douser) on

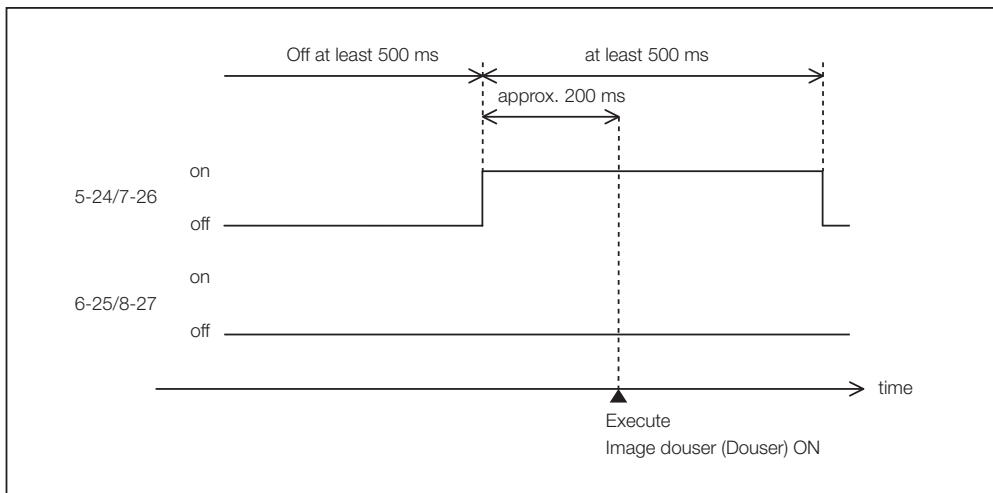

6. Appendix

Example of Light source On

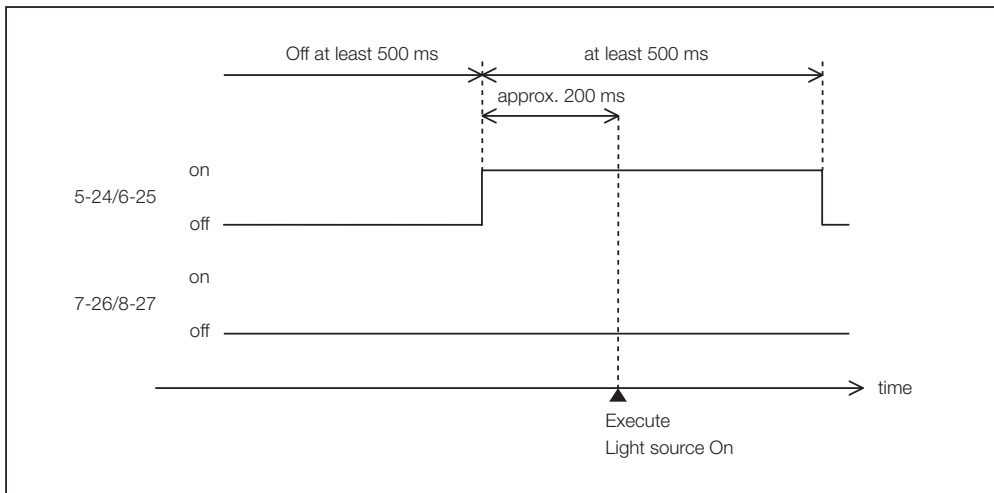

Example for turning the power off

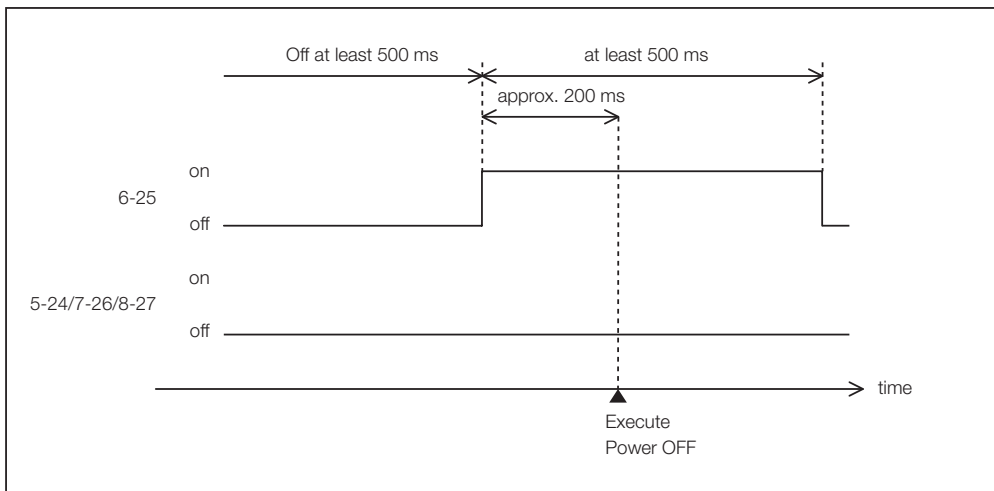

Output Connector

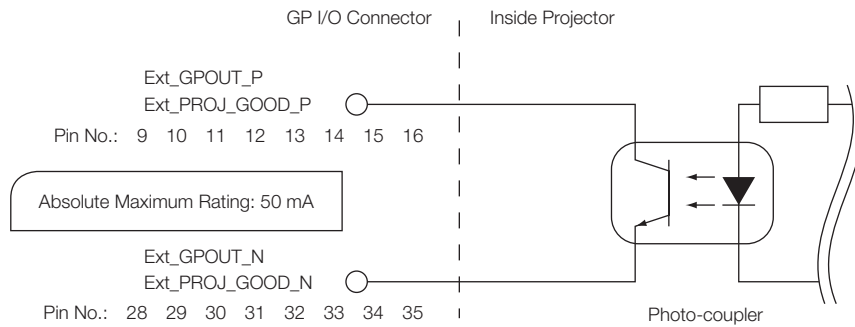

• Using GPIO Control

You can use GPIO control for the projector's health check and error check. Also, you can use the output as the trigger to control external devices.

The following functions are assigned to the pin number 13-32, 14-33, 15-34, and 16-35 (EXT_GPOUT1 - EXT_GPOUT4) as the default. You can change the assigned functions.

Pin No.	Photo-coupler ON/OFF	Function
9-28	ON/OFF	External 3D L/R timing signal output ON/OFF
10-29	-	System reserved (used internally)
11-30	-	System reserved (used internally)
12-31	ON/OFF	Internal 3D L/R timing signal output ON/OFF
13-32	ON/OFF	GPIO control status check ON: GPIO control (input) is unavailable. OFF: GPIO control (input) is available.
14-33	ON/OFF	Error check ON: Error OFF: No error
15-34	ON/OFF	IMB status check ON: The content is being played. OFF: The content is stopped/paused.
16-35	ON/OFF	Health check (heart beat) ON and OFF are alternately output when operations are normal.

6-7-3. 3D connector (D-sub 15 pin)

This is used to connect a 3D image system to the projector.

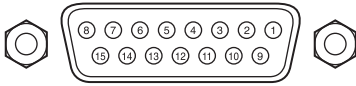

Pin view of a female connector

Pin No.	Signal Name	I/O	Function
1	+12V	PWR	Supplies power (+12V) to the 3D image system
2	GNDC	GND	Ground
3	GNDC	GND	Ground
4	RS232_RX	IN	Data transmission from the 3D image system (1200 Baud, 8 bits, No Parity)
5	RS232_TX	OUT	Data transmission to the 3D image system (1200 Baud, 8 bits, No Parity)
6	CONN_3D_MODE+	OUT	3D mode status (+) (Connects to the collector of the output transistor of the photo coupler inside the projector)
7	CONN_SYNC+	OUT	3D L/R switching timing signal (+) (Connects to the collector of the output transistor of the photo coupler inside the projector)
8	3D_INPUT_REFERENCE+	IN	3D L/R timing signal (+) (Connects to the anode of the input diode of the photo coupler inside the projector)
9	+12V	PWR	Supplies power (+12V) to the 3D image system
10	3D_INPUT_REFERENCE-	IN	3D L/R timing signal (-) (Connects to the cathode of the input diode of the photo coupler inside the projector)
11	3D_DISPLAY_REFERENCE+	IN	3D L/R display timing signal (+) (Connects to the anode of the input diode of the photo coupler inside the projector)
12	3D_DISPLAY_REFERENCE-	IN	3D L/R display timing signal (-) (Connects to the cathode of the input diode of the photo coupler inside the projector)
13	CONN_3D_MODE-	OUT	3D mode status (-) (Connects to the emitter of the output transistor of the photo coupler inside the projector)
14	CONN_SYNC-	OUT	3D L/R switching timing signal (-) (Connects to the emitter of the output transistor of the photo coupler inside the projector)
15	N/C	-	Unused

6-8. Related products list

Product name	Model name	
Lens	Zoom lens 1.20~1.80	NC-60LS12ZW
	Zoom lens 1.20~1.81	NC-60LS12Z
	Zoom lens 1.40~2.05	NC-60LS14Z
	Zoom lens 1.59~2.53	NC-60LS16Z
	Zoom lens 1.90~3.25	NC-60LS19Z
	Zoom lens 2.40~3.90	NC-60LS24Z
	Zoom lens 3.90~6.52	NC-60LS39Z
Projector Head	NP-02HD	
Light Module	Max. 22 m screen width	NP-24LU01
	Max. 22 m screen width	NP-24LU03
	Max. 20 m screen width	NP-20LU01
	Max. 20 m screen width	NP-20LU03
	Max. 19 m screen width	NP-18LU01
	Max. 19 m screen width	NP-18LU03

